

# Preface

## Copyright

This publication, including all photographs, illustrations and software, is protected under international copyright laws, with all rights reserved. Neither this manual, nor any of the material contained herein, may be reproduced without written consent of the author.

Version 1.0

## Disclaimer

The information in this document is subject to change without notice. The manufacturer makes no representations or warranties with respect to the contents hereof and specifically disclaims any implied warranties of merchantability or fitness for any particular purpose. The manufacturer reserves the right to revise this publication and to make changes from time to time in the content hereof without obligation of the manufacturer to notify any person of such revision or changes.

## Trademark Recognition

Microsoft, MS-DOS and Windows are registered trademarks of Microsoft Corp.

MMX, Pentium, Pentium-II, Pentium-III, Celeron are registered trademarks of Intel Corporation.

Other product names used in this manual are the properties of their respective owners and are acknowledged.

## Federal Communications Commission (FCC)

This equipment has been tested and found to comply with the limits for a Class B digital device, pursuant to Part 15 of the FCC Rules. These limits are designed to provide reasonable protection against harmful interference in a residential installation. This equipment generates, uses, and can radiate radio frequency energy and, if not installed and used in accordance with the instructions, may cause harmful interference to radio communications. However, there is no guarantee that interference will not occur in a particular installation. If this equipment does cause harmful interference to radio or television reception, which can be determined by turning the equipment off and on, the user is encouraged to try to correct the interference by one or more of the following measures:

- Reorient or relocate the receiving antenna.
- Increase the separation between the equipment and the receiver.
- Connect the equipment onto an outlet on a circuit different from that to which the receiver is connected.
- Consult the dealer or an experienced radio/TV technician for help.

Shielded interconnect cables and a shielded AC power cable must be employed with this equipment to ensure compliance with the pertinent RF emission limits governing this device. Changes or modifications not expressly approved by the system's manufacturer could void the user's authority to operate the equipment.

## Declaration of Conformity

This device complies with part 15 of the FCC rules. Operation is subject to the following conditions:

- This device may not cause harmful interference, and
- This device must accept any interference received, including interference that may cause undesired operation.

## Canadian Department of Communications

This class B digital apparatus meets all requirements of the Canadian Interference-causing Equipment Regulations.

Cet appareil numérique de la classe B respecte toutes les exigences du Règlement sur le matériel brouilleur du Canada.

## About the Manual

The manual consists of the following:

<b>Chapter 1</b> <b>Introducing the Mainboard</b>	Describes features of the mainboard, and provides a shipping checklist.  Go to ⇒ page 1
<b>Chapter 2</b> <b>Installing the Mainboard</b>	Describes installation of mainboard components.  Go to ⇒ page 6
<b>Chapter 3</b> <b>Using BIOS</b>	Provides information on using the BIOS Setup Utility.  Go to ⇒ page 26
<b>Chapter 4</b> <b>Using the Mainboard Software</b>	Describes the mainboard software.  Go to ⇒ page 50

## Features and Packing List Translations

### Liste de contrôle

Comparez ce qui est contenu dans l'emballage de la carte mère avec la liste suivante:

#### Éléments standards

- Une carte mère
- Un câble plat pour lecteur de disquette
- Un câble plat pour lecteur IDE
- Un CD d'installation automatique pour le logiciel
- Ce manuel utilisateur

### Caractéristiques

<b>Processeur</b>	<p>La carte mère SV266A utilise un Socket A AMD 462 broches présentant les caractéristiques suivantes:</p> <ul style="list-style-type: none"><li>• Supporte un bus frontal (FSB) de 100/133 MHz</li><li>• Reçoit des processeurs Athlon/Duron AMD</li></ul>
<b>Chipset</b>	<p>Les chipsets KT266A Northbridge et VT8235 Southbridge sont basés sur une architecture de chipset de bon rapport qualité-prix et de bon rendement énergétique pour implémenter les systèmes d'ordinateurs de bureau AGP/PCI avec une fiabilité et des performances prouvées.</p> <ul style="list-style-type: none"><li>• Supporte les processeurs Athlon AMD (Socket-462) Socket-A</li><li>• Transfert DDR (Double Data Rate) 100/133 MHz sur adresse CPU Athlon et bus de données</li><li>• Offre un contrôleur de Port Graphique Accéléré (AGP) complet conforme V2.0 et supportant les modes 1x, 2x et 4x en 66 MHz offrant des graphiques 3D éclatants, et des performances vidéo de haute qualité</li><li>• Supporte une interface d'Hôte V-Link 66 MHz avec une bande passante de pointe de 266 Mo/sec et un protocole de transaction V-Link intelligent pour éliminer l'état d'attente/latence de transfert d'accélérateur de données</li><li>• Types de mémoire SDRAM DDR et SDR de hautes performances avancés</li><li>• Contrôleur USB 2.0 intégré avec trois hubs racine et six ports de fonction</li><li>• Contrôleur EIDE de mode maître Ultra DMA 33/66/100/133 de Canal double</li></ul> <p>Les caractéristiques clé supplémentaires comprennent le support de six ports USB, une liaison AC 97 pour audio et modem et surveillance matérielle.</p>

<b>Graphiques</b>	La carte mère comprend un logement AGP qui offre quatre fois la bande passante des spécifications AGP d'origine. La technologie AGP offre une connexion directe entre le sous-système graphique et le processeur de sorte que les graphiques n'ont pas à entrer en concurrence avec d'autres périphériques pour le temps d'utilisation du processeur sur le bus PCI.
<b>Mémoire</b>	La carte mère peut recevoir les configurations de mémoire suivantes : <ul style="list-style-type: none"> <li>• SDRAM DDR (Double Data Rate) PC1600/PC2100 supportant jusqu'à 2 Go en utilisant deux modules DIMM 2.5V</li> <li>• SDRAM PC133/ PC100 supportant jusqu'à 2 Go en utilisant deux modules DIMM 3.3V</li> </ul>
<b>Audio</b>	Le codec audio est conforme aux spécifications AC 97 2.2, et supporte la résolution 18 bits ADC (Analog Digital Converter) et DAC (Digital Analog Converter) ainsi que le codec full-duplex stéréo 18 bits avec vitesses d'échantillonnage indépendantes et variables. Cette carte mère supporte une ligne de sortie jusqu'à 4 canaux.
<b>LAN Interne (optionnel)</b>	Le VT6103 est un périphérique à Couche Physique pour Ethernet 10BASE-T et 100BASE-TX utilisant des câbles Non blindés de catégorie 5, Blindés de Type 1. <ul style="list-style-type: none"> <li>• Double Vitesse – 100/10 Mbps</li> <li>• Half et Full Duplex</li> <li>• Conforme à tous les Standards IEEE 802.3, 10Base-T et 100Base-Tx Applicables</li> <li>• Egaliseur Adaptatif</li> </ul>
<b>E/S Intégrées</b>	La carte mère possède un jeu complet de ports d'E/S et de connecteurs: <ul style="list-style-type: none"> <li>• Deux ports PS/2 pour souris et clavier</li> <li>• Deux ports série</li> <li>• Un port parallèle</li> <li>• Quatre ports USB</li> <li>• Un port LAN</li> <li>• Prises audio pour microphone, ligne d'entrée et ligne de sortie</li> </ul>
<b>Microprogramme BIOS</b>	Cette carte mère utilise Award BIOS qui permet aux utilisateurs de configurer de nombreuses caractéristiques du système comprenant les suivantes: <ul style="list-style-type: none"> <li>• Gestion d'alimentation</li> <li>• Alarmes de réveil</li> <li>• Paramètres de CPU</li> <li>• Synchronisation de CPU et de mémoire</li> </ul> Le microprogramme peut aussi être utilisé pour définir les paramètres pour les vitesses d'horloges de différents processeurs.

## Checkliste

Vergleichen Sie den Packungsinhalt des Motherboards mit der folgenden Checkliste:

### Standard Items

- Ein Motherboard
- Ein Bandkabel für Diskettenlaufwerke
- Ein Bandkabel für IDE-Laufwerke
- Eine Auto-Installations-Support-CD
- Dieses Benutzerhandbuch

## Features

<b>Prozessor</b>	Das SV266A Mainboard enthält einen AMD 462-Pin Socket A mit den folgenden Eigenschaften: <ul style="list-style-type: none"><li>• Unterstützt 100/133 MHz Front-Side Bus (FSB)</li><li>• Nimmt AMD Athlon/Duron Prozessoren auf</li></ul>
<b>Chipsatz</b>	Die Chipsätze KT266A Northbridge und VT8235 Southbridge basieren auf einer kostengünstigen und energiesparenden Architektur zur Implementierung von AGP/PCI-Desktop-Computersystemen mit bewiesener Zuverlässigkeit und Leistung. <ul style="list-style-type: none"><li>• Unterstützt Socket-A (Socket-462) AMD Athlon Prozessoren</li><li>• 100/133 MHz DDR (Double Data Rate) Transfer auf Athlon CPU-Adress- und Datenbussen</li><li>• Bietet vollständigen Accelerated Graphics Port (AGP) Controller, der v2.0 entspricht und 66 MHz 1x, 2x und 4x Modi unterstützt und damit lebendige 3D-Grafik und qualitativ hochwertige Videoleistung bietet</li><li>• Unterstützt 66 MHz V-Link Host Interface mit einer Spitzenbandbreite von 266 MB/s und einem intelligenten V-Link Transaction Protocol, um Data-Wait-State/Throttle-Transfer-Latency zu beseitigen</li><li>• Erweiterte Hochleistungs-SDR und DDR SDRAM-Speichertypen</li><li>• Integrierter USB 2.0 Controller mit drei Root Hubs und sechs Funktionsschnittstellen</li><li>• Dual-Kanal Ultra DMA 33/66/100/133 Master Mode EIDE Controller</li></ul> Zusätzliche Schlüsselmerkmale umfassen die Unterstützung für sechs USB-Anschlüsse, ein AC 97-Link für Audio und Modem und Hardwareüberwachung.
<b>Grafik</b>	Dieses Mainboard umfasst einen AGP-Steckplatz mit der vierfachen Bandbreite der ursprünglichen AGP-Spezifikation. AGP-Technologie bietet eine direkte Verbindung zwischen dem Grafiksubsystem und dem Speicher, so dass die Grafik nicht mit anderen Geräten auf dem PCI-Bus um Prozessorzeit wetteifern muss.

<b>Speicher</b>	<p>Das Mainboard nimmt die folgenden Speicherkonfigurationen auf:</p> <ul style="list-style-type: none"> <li>• DDR (Double Data Rate) PC1600/PC2100 SDRAM unterstützt bis zu 2 GB unter Verwendung von zwei 2.5V DIMM-Modulen</li> <li>• SDRAM PC133/ PC100 unterstützt bis zu 2 GB unter Verwendung von zwei 3.3V DIMM-Modulen</li> </ul>
<b>Audio</b>	<p>Der Audio-Codex ist kompatibel mit der AC 97 2.2-Spezifikation und unterstützt 18-Bit ADC (Analog Digital Converter) und DAC (Digital Analog Converter)-Auflösungen sowie 18-Bit-Stereo-Vollduplex-Codex mit unabhängigen und variablen Samplingraten. Das Mainboard unterstützt bis zu 4-Kanal Line-out.</p>
<b>Integriertes LAN (optional)</b>	<p>Das VT6103 ist ein Physical-Layer-Gerät für Ethernet 10BASE-T und 100BASE-TX bei Benutzung von nicht abgeschirmten Kategorie 5-Kabeln und abgeschirmten Typ 1-Kabeln.</p> <ul style="list-style-type: none"> <li>• Zwei Geschwindigkeiten – 100/10 Mbps</li> <li>• Halb- und Vollduplex</li> <li>• Entspricht allen geltenden IEEE 802.3, 10Base-T und 100Base-Tx-Standards</li> <li>• Einstellbarer Equalizer</li> </ul>
<b>Integrierte I/O</b>	<p>Das Mainboard verfügt über einen kompletten Satz von I/O-Schnittstellen und Anschlüssen:</p> <ul style="list-style-type: none"> <li>• Zwei PS/2-Schnittstellen für Maus und Tastatur</li> <li>• Zwei serielle Schnittstellen</li> <li>• Eine parallele Schnittstelle</li> <li>• Vier USB-Schnittstellen</li> <li>• Eine LAN-Schnittstelle</li> <li>• Audiobuchsen für Mikrofon, Line-in und Line-out</li> </ul>
<b>BIOS Firmware</b>	<p>Dieses Mainboard setzt das Award BIOS ein, mit dem der Anwender viele Systemeigenschaften selbst konfigurieren kann, einschließlich der folgenden:</p> <ul style="list-style-type: none"> <li>• Energieverwaltung</li> <li>• Wake-up Alarm</li> <li>• CPU-Parameter</li> <li>• CPU- und Speichertiming</li> </ul> <p>Mit der Firmware können auch die Parameter für verschiedene Prozessortaktgeschwindigkeiten eingestellt werden.</p>

## Lista di controllo

Comparete il contenuto della confezione della scheda madre con la seguente lista di controllo:

### Articoli standard

- Una scheda madre
- Un cavo a nastro per il drive dischetti
- Un cavo a nastro IDE
- Un CD di supporto software auto-installante
- Il manuale dell'utente

## Caratteristiche

<b>Processore</b>	<p>La scheda madre SV266A usa un socket AMD 462-pin Socket A con le seguenti caratteristiche:</p> <ul style="list-style-type: none"><li>• Supporto per il bus di sistema frontside (FSB) 100/133 MHz</li><li>• Alloggia processori AMD Athlon/Duron.</li></ul>
<b>Chipset</b>	<p>I chipset KT266A Northbridge and VT8235 Southbridge sono basati su un'architettura efficace nei costi, innovativa e efficiente nei consumi per l'implementazione di sistemi personal computer AGP/PCI con provata affidabilità e prestazioni.</p> <ul style="list-style-type: none"><li>• Supporta processori AMD Athlon Socket A (Socket 462)</li><li>• Trasferimento 100/133 MHz DDR (Double Data Rate) su bus indirizzo e dati CPU Athlon</li><li>• Fornisce una porta grafica accelerata (AGP) completa compatibile v2.0 e supporta le modalità 1x, 2x e 4x 66MHz per la fornitura di grafica 3D e alta qualità di prestazioni video.</li><li>• Supporta interfaccia V-Link Host 66 MHz con un picco di banda 266 MB/s e protocollo di transazione intelligente V-Link per eliminare latenza di trasferimento stato wait data/throttle</li><li>• Tipi di memoria SDR e DDR SDRAM ad alte prestazioni avanzate</li><li>• Controller USB 2.0 integrata con tre hub root e sei porte funzione.</li><li>• Controller EIDE modalità master doppio canale Ultra DMA 33/66/100/133</li></ul> <p>Funzioni supplementari includono sei porte USB un collegamento AC97 audio e modem e monitoraggio hardware.</p>
<b>Grafica</b>	<p>La scheda madre include uno slot AGP che fornisce quattro volte la larghezza di banda delle specifiche AGP originarie. La tecnologia AGP fornisce un collegamento diretto tra il sottosistema grafico e il processore in modo che la grafica non deve competere con le altre periferiche presenti sul bus PCI per avere tempo processore.</p>

<b>Memoria</b>	<p>La scheda madre alloggia le seguenti configurazioni di memoria:</p> <ul style="list-style-type: none"> <li>• DDR (Double Data Rate) PC1600/PC2100 SDRAM con supporto fino a 2 GB con due moduli DIMM 2.5V</li> <li>• SDRAM PC133/ PC100 supporta fino a 2 GB usando due moduli DIMM 3,3V.</li> </ul>
<b>Audio</b>	<p>Il code audio è compatibile con le specifiche AC 97 2.2 e supporta una risoluzione a 18 bit ADC (convertitore analogico digitale) e DAC (convertitore digitale analogico) come pure codec full duplex 18 bit con frequenze di campionamento indipendenti e variabili. La scheda madre supporta una linea di uscita fino a 4 canali</p>
<b>LAN integrata (Opzionale)</b>	<p>La scheda VT6103 è una periferica Physical Layer per Ethernet 10BASE-T e 100BASE-TX usando cavi schermati tipo 1 e non schermati categoria 5</p> <ul style="list-style-type: none"> <li>• Doppia velocità – 100/10 Mbps</li> <li>• Half e Full duplex.</li> <li>• Conforme a tutti gli standard applicabili IEEE802.3, 10Base-T e 100Base-TX</li> <li>• Equalizzatore adattivo</li> </ul>
<b>Inizializza I/O</b>	<p>La scheda madre è dotata da una serie completa di porte e connettori I/O:</p> <ul style="list-style-type: none"> <li>• Due porte PS/2 per tastiera e mouse</li> <li>• Due porte seriali</li> <li>• Una porta parallela</li> <li>• Quattro porte USB</li> <li>• Una porta LAN</li> <li>• Jack audio per microfono, ingresso linea e uscita linea</li> </ul>
<b>Firmware BIOS</b>	<p>Questa scheda madre adotta un BIOS Award che permette agli utenti di configurare le caratteristiche principali del sistema, inclusi:</p> <ul style="list-style-type: none"> <li>• Gestione energia</li> <li>• Allarmi wake up</li> <li>• Parametri CPU</li> <li>• Temporizzazione CPU e memoria</li> </ul> <p>Il firmware può anche essere usato per impostare i parametri per diverse velocità di clock.</p>

## Lista de Verificación

Compare los contenidos del paquete de la placa principal con la sigte. lista:

### Ítems Estándares

- Una placa principal
- Un cable cinta del lector de diskette
- Un cable cinta de la unidad IDE
- Un CD de soporte en software de autoinstalación
- Este manual del usuario

## Características

<b>Procesador</b>	La placa principal SV266A usa una AMD 462-pin Socket A que tiene las sigtes. características: <ul style="list-style-type: none"><li>• Soporta bus de lado frontal (FSB) 100/133 MHz</li><li>• Acomoda procesadores AMD Athlon/Duron</li></ul>
<b>Chipset</b>	Los chipsets KT266A Northbridge y VT8235 Southbridge se basan de la arquitectura de chipset eficiente de energía y de costo para implementar sistemas de ordenador personal AGP/PCI con fiabilidad y rendimiento comprobados. <ul style="list-style-type: none"><li>• Soporta procesadores Socket-A (Socket-462) AMD Athlon</li><li>• Transferencia 100/133 MHz DDR (Índice de Datos Double/Double Data Rate) en dirección Athlon CPU y buses de datos</li><li>• Provee controlador Accelerated Graphics Port (AGP) con funciones completas que se conforman con v2.0 y soporta modos 66 MHz 1x, 2x y 4x que entregan gráficas 3D vivas y rendimiento de vídeo de alta calidad</li><li>• Soporta interfaz 66 MHz V-Link Host con una ancha de banda máxima de 266 MB/s y un protocolo de transacción V-Link inteligente para eliminar demora de transferencia estado de espera/ahogado de datos</li><li>• Tipos de memoria SDR y DDR SDRAM de alto rendimiento</li><li>• Controlador USB 2.0 Integrado con tres hubs de raíz y puertos de seis funciones</li><li>• Controlador EIDE de modo máster de Dual Channel Ultra DMA 33/66/100/133</li></ul> Las características claves adicionales incluyen soporte para seis puertos USB, un vínculo AC 97 para sonido y módem y monitoreo de hardware.
<b>Memoria</b>	La placa principal acomoda las sigtes. configuraciones de memoria: <ul style="list-style-type: none"><li>• DDR (Double Data Rate) PC1600/PC2100 SDRAM soporta hasta 2 GB con dos módulos de 2.5V DIMM</li><li>• SDRAM PC133/ PC100 soporta hasta 2 GB con dos módulos de 3.3V DIMM</li></ul>

<b>Gráficas</b>	La placa principal incluye una ranura AGP que provee cuatro veces la ancha de banda de la especificación AGP original. La tecnología AGP provee una conexión directa entre el subsistema de gráficas y el procesador para que las gráficas no tengan que competir por el tiempo de procesador con otros dispositivos en el bus PCI.
<b>Sonido</b>	El codec de sonido se conforma con la AC 97 2.2, y soporta 18-bit ADC (Conversor Digital Analógico/Analog Digital Converter) y resolución DAC (Conversor Analógico Digital/Digital Analog Converter) y también codec de full-duplex de estéreo de 18-bit con índice de muestreo independiente y variable. Esta placa principal soporta hasta salida de de línea de 4 canales.
<b>LAN abordo (optativo)</b>	El VT6103 es un dispositivo de Capa Física para Ethernet 10BASE-T y 100BASE-TX con cables de la categoría 5 Sin protección, y de Tipo 1 con protección <ul style="list-style-type: none"> <li>• Velocidad Dual – 100/10 Mbps</li> <li>• Duplex Medio y Completo</li> <li>• Satisface todas las normas IEEE 802.3, 10Base-T y 100Base-Tx</li> <li>• Ecualizador Adaptivo</li> </ul>
<b>I/O Integrado</b>	La placa principal tiene un juego completo de puertos y conectores I/O: <ul style="list-style-type: none"> <li>• Dos puertos PS/2 para ratón y teclado</li> <li>• Dos puertos seriales</li> <li>• Un puerto paralelo</li> <li>• Cuatro puertos USB</li> <li>• Un puerto LAN</li> <li>• Clavijas de sonido para micrófono, entrada y salida de línea</li> </ul>
<b>Firmware de BIOS</b>	Esta placa principal usa Award BIOS que habilita los usuarios a configurar muchas características de sistema que incluyen las sigtes: <ul style="list-style-type: none"> <li>• Administración de energía</li> <li>• Alarmas despertadoras</li> <li>• Parámetros de CPU</li> <li>• CPU y cronometraje de memoria</li> </ul> <p>El firmware también se puede usar para configurar parámetros para diferentes velocidades de reloj.</p>

## チェックリスト

下記のチェックリストに列挙されている製品が同封されているかを確認してください。

### 標準同封アイテム

- メインボード 1枚
- ディスクドライブ用リボンケーブル 1個
- IDEドライブ用リボンケーブル 1個
- 自動インストール機能対応ソフトウェアCD 1枚
- ユーザーマニュアル

## 製品特徴

プロセッサ	SV266Aメインボードは以下の機能を備えたAMD 462ピンソケットAを搭載しています： <ul style="list-style-type: none"><li>• 100/133 MHzシステムバス (FSB) 対応</li><li>• AMD Athlon/Duronプロセッサ対応</li></ul>
チップセット	KT266A NorthbridgeとVT8235 Southbridgeチップセットは、AGP/PCIを搭載したデスクトップコンピュータのための経済的で、省電力性に優れたチップセット構造を持ち、高い安定性およびパフォーマンスが保証されています。 <ul style="list-style-type: none"><li>• ソケットA (ソケット-462) AMD Athlonプロセッサをサポート</li><li>• Athlon CPUアドレスとデータバスにおける100/133 MHz DDR (Double Data Rate) 転送</li><li>• V2.0準拠の完全機能AGP (Accelerated Graphics Port) コントローラを提供し、さらに66MHz 1x、2x、4xモードで鮮明な3Dグラフィックと高画質ビデオパフォーマンスを提供</li><li>• 最大帯域幅266 MB/秒の66MHz V-Linkホストインターフェースと、データ待機状態/混雑による転送の遅延を防ぐための知的V-Linkトランスアクションプロトコル対応</li><li>• 高性能SDRとDDR SDRAMメモリタイプ</li><li>• 3つのルートハブと6つの機能ポートを備えた統合USB 2.0コントローラ</li><li>• デュアルチャンネルUltra DMA 33/66/100/133ますた一モードEIDEコントローラ</li></ul> この他に、6つのUSBポート、オーディオとモデムのためのAC 97リンク、ハードウェアモニタなどの機能を搭載しています。
グラフィック	このメインボードには、本来のAGP仕様の4倍の帯域幅を提供することができるAGPスロットが含まれます。AGP技術はグラフィックサブシステムとプロセッサとの間の直接接続を提供するため、グラフィックがPCIバス上のその他と競合することがなくなります。

<b>メモリ</b>	<p>このメインボードは、次のメモリ設定に対応しています：</p> <ul style="list-style-type: none"> <li>• 2.5V DIMMモジュールを使い、最大2 GBまでDDR (Double Data Rate) PC1600/PC2100 SDRAMをサポート</li> <li>• 2つの3.3V DIMMモジュールを使い、最大2 GBまでSDRAM PC133/ PC100をサポート</li> </ul>
<b>オーディオ</b>	<p>オーディオコーデックはAC 97 2.2 仕様に適合したもので、18ビットADC (Analog Digital Converter) とDAC (Digital Analog Converter) 解決と、独立した可変サンプリングレートの18ビットステレオ全二重コーデックに対応しています。このメインボードは、最大4チャンネルのライン出力に対応しています。</p>
<b>オンボードLAN (オプション)</b>	<p>VT6103は、カテゴリ5アンシールド、タイプ1シールドケーブルを使ったイーサネット10BASE-Tと100BASE-TXの物理レイヤーデバイスです。</p> <ul style="list-style-type: none"> <li>• デュアルスピード - 100/10 Mbps</li> <li>• 半/全二重</li> <li>• すべての適合IEEE 802.3、10Base-T、および100Base-Tx標準に対応</li> <li>• 適応エコライザ</li> </ul>
<b>統合の入出力ポート</b>	<p>このメインボードはフルセットのI/Oポートおよびコネクタを搭載しています。</p> <ul style="list-style-type: none"> <li>• マウスとキーボード用の2つのPS/2ポート</li> <li>• リアルポート x 2</li> <li>• パラレルポート x 1</li> <li>• USBポート x 4</li> <li>• LANポート x 1</li> <li>• マイクロフォンやラインイン、ラインアウト向けのオーディオジャック</li> </ul>
<b>BIOS ファームウェア</b>	<p>このメインボードは次のシステム機能を含めた設定をすることができるAward BIOSを採用しています：</p> <ul style="list-style-type: none"> <li>• 電源管理</li> <li>• Wake-up警告</li> <li>• CPUパラメータ</li> <li>• CPUおよびメモリのタイミング</li> </ul> <p>この他に、各種プロセッサクロック速度のパラメータを設定することができます。</p>

## 품목 목록

다음 품목들이 메인보드 패키지에 모두 포함되어 있는지 확인해 보십시오:

### 표준 품목

- 메인 보드 1개
- 디스켓 드라이브 리본 케이블 1개
- IDE 드라이브 리본 케이블 1개
- 자동 설치 소프트웨어 지원 CD 1개
- 본 사용자 설명서

## 기능

프로세서	<p>SV266A 메인보드는 다음과 같은 특징을 지닌 AMD 462 핀 소켓 A를 사용한다:</p> <ul style="list-style-type: none"> <li>• 100/133 MHz frontside bus (FSB) 지원</li> <li>• AMD Athlon/Duron 프로세서 사용</li> </ul>
칩셋	<p>KT266A Northbridge 및 VT8235 Southbridge 칩셋은 비용 효율적이고 에너지 효율적인 칩셋 아키텍처를 바탕으로 하여 AGP/PCI □□□□ □□□ □□□ □□□에 인□□ □□□□□□을 □□한다.</p> <ul style="list-style-type: none"> <li>• 소켓 A (소켓 462) AMD Athlon 프로세서 지원</li> <li>• Athlon CPU □드□□ 및 □이□ □□에 100/133 MHz DDR (Double Data Rate) □□</li> <li>• V2.0과 □□하고 66 MHz 1x, 2x 및 4x □드□를 지원하여 □□한 3D □□□□□□□□□□□□□□□□을 □□하는 Accelerated Graphics Port (AGP) □□□□ □□</li> <li>• 데이터 대기 상태 제거/전송 숨김 조절을 위한 최고 대역폭 266 MB/s 및 우수한 V 링크 전송 프로토콜의 66 MHz V 링크 호스트 인터페이스 지원</li> <li>• 고급 고성능 SDR 및 DDR SDRAM 메모리 타입</li> <li>• 3 개□ □□ □브 및 6 개□□□ □□□를 지닌 USB 2.0 □□□□</li> <li>• 듀얼 채널 Ultra DMA 33/66/100/133 마스터 모드 EIDE 컨트롤러</li> </ul> <p>이외의 주요 특징으로 USB 포트 6개, 오디오 및 모뎀용 AC 97 링크, 하드웨어 모니터링이 있다.</p>
그래픽	<p>본 메인보드는 기존 AGP 사양보다 4배의 대역폭을 제공하는 AGP 슬롯 1개가 포함되어 있다. AGP 기술은 그래픽 하부 시스템과 프로세서를 직접 연결함으로써 그래픽이 PCI에 있는 다른 장치와 프로세서 시간을 다룰 필요가 없다.</p>
메모리	<p>본 메인보드는 다음과 같은 메모리 구성을 지닌다:</p> <ul style="list-style-type: none"> <li>• DDR (Double Data Rate) PC1600/PC2100 SDRAM은 2.5V DIMM □□ 2 개를 사용하여 □□ 2 GB □지 지원한다</li> <li>• SDRAM PC133/ PC100 은 3.3V DIMM □□을 사용하여 □□ 2 GB□지 지원한다</li> </ul>

<b>오디오</b>	오디오 코덱은 AC 97 2.2 사양과 호환하며 독립적이고 다양한 샘플링 속도로 18 비트 ADC (Analog Digital Converter) 및 DAC (Digital Analog Converter) 해결은 물론 18 비트 스테레오 full-duplex 코덱을 지원한다. 본 메인보드는 최대 4 채널 라인 출력을 지원한다.
<b>보드 내장 LAN (선택 사항)</b>	VT6103은 □□코리 5 □□드, □□ 1 □드 케이블을 사용하는 이□□ 10BASE-T 및 100BASE-TX를 □한 □리적 □이□ □□이다. <ul style="list-style-type: none"> <li>• 듀얼 속도 - 100/10 Mbps</li> <li>• Half 및 Full Duplex</li> <li>• IEEE 802.3, 10Base-T 및 100Base-Tx □□ □□</li> <li>• 적용 가능한 이퀄라이저</li> </ul>
<b>통합 I/O</b>	본 메인보드는 풀 세트의 I/O 포트 및 커넥터가 있다: <ul style="list-style-type: none"> <li>• 마우스와 키보드용 PS/2 포트 2개</li> <li>• 시리얼 포트 2개</li> <li>• 패러럴 포트 1개</li> <li>• USB □□ 4개</li> <li>• LAN □□ 1개</li> <li>• 마이크용 오디오 잭, 라인 입력 및 라인 출력</li> </ul>
<b>BIOS 펌웨어</b>	본 메인보드는 Award BIOS를 사용하여 다음과 같은 시스템 기능을 구성할 수 있다 : <ul style="list-style-type: none"> <li>• 전원관리</li> <li>• 기상 알람</li> <li>• CPU □라□□</li> <li>• CPU 및 메모리 □이□</li> </ul> □□□는 다□ 프로세서 □□ □도□ □라□□ 설□에도 사용될 수 있다.

## 檢查表

請依下列檢查表，核對主機板包裝之內容：

### 標準項目

- 主機板一片
- 磁碟機排線一條
- IDE磁碟機排線一條
- 自動安裝CD一片
- 本使用手冊

### 性能

<b>處理器</b>	SV266A主機板採用具有下列 AMD 462 Socket A: <ul style="list-style-type: none"> <li>• 支援100/133MHz前端匯流排(FSB)</li> <li>• 支援AMD Athlon/Duron 處理器</li> </ul>
<b>晶片組</b>	KT266A VT8235 採 AGP/PCI <ul style="list-style-type: none"> <li>• 支援Socket-A (Socket-462) AMD Athlon處理器</li> <li>• 支援Athlon CPU位址與資料匯流排達100/133 MHz DDR (Double Data Rate)傳輸速率</li> <li>• 支援AGP (Accelerated Graphics Port) 控制器，容 v2.0，支援66 MHz 1x, 2x 4x，輸 3D</li> <li>• 支援 66MHz之 V-Link 主控，達266MB/sec 之，V-Link傳輸 資料 / 傳輸</li> <li>• 支援 SDR DDR SDRAM</li> <li>• USB 2.0控制器，主 線器</li> <li>• 內 UltraDMA- 33/66/100/133 主 EDIE控制器 包：支援6 USB 機 用 AC 97 硬 監視。</li> </ul>
<b>Graphics</b>	本主機板搭載 一 AGP插槽，當 舊 AGP規格4倍之。AGP技術，係使繪 子系統與中央處理器直，藉使繪 系統 需與PCI插槽上 設備，爭取處理器資源。
<b>記憶體</b>	本主機板配備 下列 設： <ul style="list-style-type: none"> <li>• 使用2 2.5V DIMM 組，支援 達2GB之DDR (Double Data Rate) PC1600/PC2100 SDRAM</li> <li>• 使用2 3.3V DIMM 組，支援 達2GB之 SDRAM PC133/ PC100</li> </ul>
<b>音效</b>	配備之 解碼/編碼器，係採用AC' 97 2.2 規格，支援18位元 ADC(類比 位轉換器) DAC( 位類比轉換器)解析度，同 也支援具 18位元 獨立或 變取 率之立 解碼/編碼器。，也支援類比 立 4 之輸。

<b>機載 LAN (選購)</b>	<p>VT6103 10BASE-T 100BASE-TX 用 Category 5( 100 Mbps) 線, Type 1</p> <ul style="list-style-type: none"> <li>• 倍速 – 100/10 Mbps 傳輸速率</li> <li>• 支援 或</li> <li>• 用 用之IEEE 802.3, 10BaseT 100Base-Tx 線, 之</li> <li>• 自 器</li> </ul>
<b>整合的輸入出功能</b>	<p>本主機板 支援 I輸 器 :</p> <ul style="list-style-type: none"> <li>• 2 PS/2</li> <li>• 2 列</li> <li>• 1</li> <li>• 4 USB</li> <li>• 1 LAN</li> <li>• line-in line-out 端</li> </ul>
<b>BIOS 韌體</b>	<p>本主機板使用 AWARD BIOS , 使用 藉 對包 下列之系統 設 :</p> <ul style="list-style-type: none"> <li>• 源 理</li> <li>•</li> <li>• CPU</li> <li>• CPU</li> </ul> <p>BIOS 用 有</p>

## 校验表

将本主板的组件内容与以下校验表进行对照：

### 标准组件

- 一只主板
- 一条磁盘驱动器带状电缆
- 一条 IDE 驱动器带状电缆
- 一个保持模块
- 一张自动安装软件支持光盘
- 本用户手册

### 特性

<b>处理器</b>	SV266A 主板使用一个 AMD 462-pin Socket A 插座，此插座具有以下特点： <ul style="list-style-type: none"><li>• 支持 100/133 MHz 前端总线 (FSB)</li><li>• 支持 AMD Athlon/Duron 处理器</li></ul>
<b>芯片组</b>	KT266A 北桥和 VT8235 南桥芯片组是基于一种低成本的高效能芯片组架构，用于 AGP/PCI 个人电脑，能提供已经证明的可靠性和高性能。 <ul style="list-style-type: none"><li>• 支持 Socket-A (Socket-462) AMD Athlon 处理器</li><li>• Athlon CPU 地址和数据总线上100/133 MHz DDR MHz DDR (双数据传输速率) 传输</li><li>• 提供全功能的加速图形接口 (AGP) 控制器 (兼容于 v2.0)，支持66 MHz 1x、2x 和 4x 模式，能够提供清晰的 3D 图形和高质量的视频性能</li><li>• 支持 266 MB/s 峰值带宽的 66 MHz V-Link 主控接口，支持智能 V-Link 传输协议，能够减少数据等待和传输延迟</li><li>• 高性能SDR 和 DDR SDRAM 内存类型</li><li>• 集成 USB 2.0 控制器，带有 3 个 Root Hub 和 6 个功能端口</li><li>• 双通道DMA 33/66/100/133 主控模式 EIDE 控制器</li></ul> 其它主要功能包括支持 6-个 USB 端口、用于音频和调制解调器的 AC 97 连接以及硬件监测。
<b>图形</b>	该主板包括一个 AGP 插槽，可提供普通 AGP 规格 4-倍的带宽。AGP 技术能提供图像子系统和处理器之间的直接连接，这样图像就不需要与 PCI 总线上的其它设备争用处理器时间。
<b>内存</b>	此主板支持以下内存配置： <ul style="list-style-type: none"><li>• 2 条 2.5V DIMM DDR (双数据速率) PC1600/PC2100 SDRAM 内存条，最大可支持 2 GB</li><li>• 2 条 3.3V DIMM PC133/PC100 SDRAM 内存条，最大可支持 2 GB</li></ul>

<b>声音</b>	音频编解码器兼容 AC' 97 2,2 规格, 支持 18 位 ADC (模拟数字转换器) 和 DAC (数字模拟转换器) 精度, 并支持具有独立和可调采样速率的 18 位立体声全双工编解码器。该主板支持 4 路线输出。
<b>Onboard LAN (可选)</b>	<p>VT6103 是一种物理层设备, 可用于使用 5 类非屏蔽线、1 类屏蔽线的以太网 10BASE-T 和 100BASE-TX。</p> <ul style="list-style-type: none"> <li>• 双速 - 100/10 Mbps</li> <li>• 半双工和全双工</li> <li>• 符合所有相应的 IEEE 802.3、10Base-T 和 100Base-Tx 标准</li> <li>• 自适应均衡器</li> </ul>
<b>集成 I/O</b>	<p>此主板具有完整的 I/O 端口和插孔:</p> <ul style="list-style-type: none"> <li>• 2 个 PS/2 端口用于连接鼠标和键盘</li> <li>• 2 个串口</li> <li>• 1 个并口</li> <li>• 4 个 USB 端口</li> <li>• 1 个 LAN 端口</li> <li>• 麦克风、线入和线出声音插孔</li> </ul>
<b>BIOS</b>	<p>此主板使用 Award BIOS, 可以让用户自己配置以下系统功能:</p> <ul style="list-style-type: none"> <li>• 电源管理</li> <li>• 唤醒报警</li> <li>• CPU 参数</li> <li>• CPU 和记忆定时</li> </ul> <p>还可用于设置不同处理器时钟速度的参数。</p>

---

## TABLE OF CONTENTS

<b>Preface</b>	<b>i</b>
<b>Features and Packing List Translations</b>	<b>iii</b>
<b>CHAPTER 1</b>	<b>1</b>
<b>Introducing the Mainboard</b>	<b>1</b>
<i>Introduction</i> .....	1
<i>Checklist</i> .....	1
Standard Items.....	1
<i>Features</i> .....	2
<i>Choosing a Computer Case</i> .....	3
<i>Mainboard Components</i> .....	4
<b>CHAPTER 2</b>	<b>6</b>
<b>Installing the Mainboard</b>	<b>6</b>
<i>Safety Precautions</i> .....	6
<i>Quick Guide</i> .....	6
<i>Installing the Mainboard in a Case</i> .....	7
<i>Checking Jumper Settings</i> .....	7
Setting Jumpers.....	7
Checking Jumper Settings.....	8
Jumper Settings.....	8
<i>Connecting Case Components</i> .....	10
Front Panel Connector.....	12
<i>Installing Hardware</i> .....	13
Installing the Processor.....	13
Installing Memory Modules.....	15
Installing a Hard Disk Drive/CD-ROM.....	17
Installing a Floppy Diskette Drive.....	19
Installing Add-on Cards.....	20
Connecting Optional Devices.....	22
<i>Connecting I/O Devices</i> .....	24
External Connector Color Coding.....	25
<b>CHAPTER 3</b>	<b>26</b>
<b>Using BIOS</b>	<b>26</b>
<i>About the Setup Utility</i> .....	26
The Standard Configuration.....	26
Starting Setup.....	27
Updating the BIOS.....	28
<i>Using BIOS</i> .....	29
Standard CMOS Features.....	29
Advanced BIOS Setup.....	31

Advanced Chipset Setup .....	33
Integrated Peripherals .....	37
Power Management Setup .....	41
PNP/PCI Configurations .....	45
PC Health Status .....	46
Frequency Control .....	47
Load Fail-Safe Defaults Option .....	48
Load Optimized Defaults Option .....	48
Set Password Option .....	48
Save & Exit Setup Option .....	49
Exit Without Saving .....	49

**CHAPTER 4** **50**

<b>Using the Mainboard Software</b> .....	<b>50</b>
<i>About the Software CD-ROM</i> .....	50
<i>Auto-installing under Windows 98/ME/2000/XP</i> .....	50
Running Setup .....	51
<i>Manual Installation</i> .....	53
<i>Utility Software Reference</i> .....	53

*Chapter 1*

## Introducing the Mainboard

---

### Introduction

Thank you for choosing the SV266A mainboard. The SV266A is a high performance and high quality mainboard which is built around the latest and fastest VIA KT266A + VT8235 chipset providing superior performance between the CPU, DRAM, AGP bus, and V-Link bus with pipelined, burst and concurrent operation. This mainboard supports Socket 462 that accommodates AMD Athlon processors with a frontside bus (FSB) speeds up to 133MHz.

The KT266A supports four banks of SDR/DDR Synchronous DRAMs up to 2GB for unbuffered modules. It also fully supports full AGP v2.0 capability for maximum bus utilization including 1x, 2x and 4x mode transfers, SBA (Side-Band Addressing), Flush/Fence commands and pipelined grants.

The VT8235 Southbridge supports standard intelligent peripheral controllers such as USB v2.0/1.1 and Universal HCI v2.0/1.1 compliant, real time clock with 256 byte extended CMOS, integrated bus-mastering dual full-duplex direct-sound AC97 link compatible sound system and full System Management Bus (SMBus) interface.

Sufficient expansion is provided for with one AGP slot, five 32-bit PCI slot and one CNR slot. It also comes with a built-in Enhanced PCI Bus Master PCI IDE controller that provides high-speed connections to full range of IDE devices such as HDD and CD-ROM. This mainboard is designed in a standard ATX form factor using a 4-layer printed circuit board and measures 305 mm x 244 mm.

---

### Checklist

Compare the mainboard's package contents with the following checklist:

#### Standard Items

- One mainboard
- One diskette drive ribbon cable
- One IDE drive ribbon cable
- One auto-install software support CD
- This user's manual

## Features

<b>Processor</b>	<p>The SV266A mainboard uses an AMD 462-pin Socket A that has the following features:</p> <ul style="list-style-type: none"> <li>• Supports 100/133 MHz frontside bus (FSB)</li> <li>• Accommodates AMD Athlon/Duron processors</li> </ul>
<b>Chipset</b>	<p>The KT266A Northbridge and VT8235 Southbridge chipsets are based on cost-effective and energy efficient chipset architecture for implementing AGP/PCI desktop personal computer systems with proven reliability and performance.</p> <ul style="list-style-type: none"> <li>• Supports Socket-A (Socket-462) AMD Athlon processors</li> <li>• 100/133 MHz DDR (Double Data Rate) transfer on Athlon CPU address and data buses</li> <li>• Provides full featured Accelerated Graphics Port (AGP) controller which is v2.0 compliant and supports 66 MHz 1x, 2x and 4x modes delivering vivid 3D graphics and high quality video performance</li> <li>• Supports 66 MHz V-Link Host interface with a peak bandwidth of 266 MB/s and an intelligent V-Link transaction protocol to eliminate data wait-state/throttle transfer latency</li> <li>• Advanced high-performance SDR and DDR SDRAM memory types</li> <li>• Integrated USB 2.0 Controller with three root hubs and six function ports</li> <li>• Dual Channel Ultra DMA 33/66/100/133 master mode EIDE controller</li> </ul> <p>Additional key features include support for six USB ports, an AC 97 link for audio and modem and hardware monitoring.</p>
<b>Graphics</b>	<p>The mainboard includes an AGP slot that provides four times the bandwidth of the original AGP specification. AGP technology provides a direct connection between the graphics sub-system and the processor so that the graphics do not have to compete for processor time with other devices on the PCI bus.</p>
<b>Memory</b>	<p>The mainboard accommodates the following memory configurations:</p> <ul style="list-style-type: none"> <li>• DDR (Double Data Rate) PC1600/PC2100 SDRAM supports up to 2 GB using two 2.5V DIMM modules</li> <li>• SDRAM PC133/ PC100 supports up to 2 GB using two 3.3V DIMM modules</li> </ul>
<b>Audio</b>	<p>The audio codec is compliant with the AC 97 2.2 specification, and supports 18-bit ADC (Analog Digital Converter) and DAC (Digital Analog Converter) resolution as well as 18-bit stereo full-duplex codec with independent and variable sampling rates. This mainboard supports up to 4-channel line out.</p>

<b>Onboard LAN (optional)</b>	<p>The VT6103 is a Physical Layer device for Ethernet 10BASE-T and 100BASE-TX using category 5 Unshielded, Type 1 Shielded cables</p> <ul style="list-style-type: none"> <li>• Dual Speed – 100/10 Mbps</li> <li>• Half And Full Duplex</li> <li>• Meet All Applicable IEEE 802.3, 10Base-T and 100Base-Tx Standards</li> <li>• Adaptive Equalizer</li> </ul>
<b>Integrated I/O</b>	<p>The mainboard has a full set of I/O ports and connectors:</p> <ul style="list-style-type: none"> <li>• Two PS/2 ports for mouse and keyboard</li> <li>• Two serial port</li> <li>• One parallel port</li> <li>• Four USB ports</li> <li>• One LAN port</li> <li>• Audio jacks for microphone, line-in and line-out</li> </ul>
<b>BIOS Firmware</b>	<p>This mainboard uses Award BIOS that enables users to configure many system features including the following:</p> <ul style="list-style-type: none"> <li>• Power management</li> <li>• Wake-up alarms</li> <li>• CPU parameters</li> <li>• CPU and memory timing</li> </ul> <p>The firmware can also be used to set parameters for different processor clock speeds.</p>

---

## Choosing a Computer Case

There are many types of computer cases on the market. The mainboard complies with the specifications for the ATX system case. Some features on the mainboard are implemented by cabling connectors on the mainboard to indicators and switches on the system case. Ensure that your case supports all the features required. The mainboard can support one or two floppy diskette drives and four enhanced IDE drives. Ensure that your case has sufficient power and space for all the drives that you intend to install.

Most cases have a choice of I/O templates in the rear panel. Make sure that the I/O template in the case matches the I/O ports installed on the rear edge of the mainboard.

This mainboard has an ATX form factor of 305 x 244 mm. Choose a case that accommodates this form factor.

## Mainboard Components

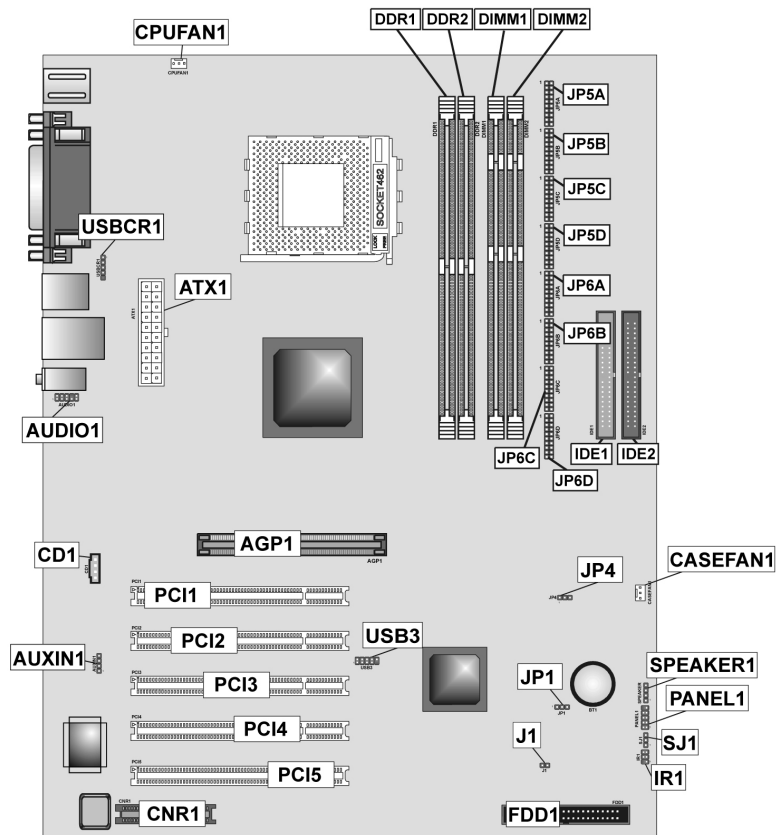

## Table of Mainboard Components

Label	Component
AGP1	Accelerated Graphics Port
ATX1	Power connector
AUDIO1	Front-oriented microphone/line-out port header
AUXIN1	Extra line-in connector
BT1	Three volt realtime clock battery
CASEFAN1	Auxiliary case cooling fan
CD1	CD-in connector
CNR1	Communications Networking Riser slot
CPUFAN1	Cooling fan for CPU
CPU Socket	Socket A for AMD Athlon processor
DDR1~DDR2	Two 184 pin DDR SDRAM sockets
DIMM1 ~ DIMM2	Two 168 pin DIMM sockets
FDD1	Floppy disk drive connector
IDE 1	Primary IDE channel
IDE 2	Secondary IDE channel
J1	Case open detecting connector (optional)
JP1	Clear CMOS jumper
JP4	CPU frequency selection jumper
JP5A/B/C/D, JP6A/B/C/D	DDR/SDR DRAM type selector
PANEL1	Connector for case front panel switches and LED indicators
PCI1 ~ PCI5	Five 32-bit add-in card slots
IR1	Infrared cable header
SPEAKER1	Speaker connector
USB3	Front panel USB headers
USBCR1	USB card reader connector

This concludes Chapter 1. The next chapter explains how to install the mainboard.

---

---

## *Chapter 2*

# Installing the Mainboard

---

### **Safety Precautions**

Follow these safety precautions when installing the mainboard:

- Wear a grounding strap attached to a grounded device to avoid damage from static electricity.
- Discharge static electricity by touching the metal case of a safely grounded object before working on the mainboard.
- Leave components in the static-proof bags they came in.
- Hold all circuit boards by the edges. Do not bend circuit boards.

---

### **Quick Guide**

This Quick Guide suggests the steps you can take to assemble your system with the mainboards.

The following table provides a reference for installing specific components:

<b>Locating Mainboard Components</b>	Go to page 4
<b>Installing the Mainboard in a Case</b>	Go to page 7
<b>Setting Jumpers</b>	Go to page 7
<b>Installing Case Components</b>	Go to page 10
<b>Installing the CPU</b>	Go to page 13
<b>Installing Memory</b>	Go to page 15
<b>Installing an HDD and CD-ROM Drive</b>	Go to page 17
<b>Installing an FDD</b>	Go to page 19
<b>Installing Add-on Cards</b>	Go to page 20
<b>Connecting Options</b>	Go to page 22
<b>Connecting Peripheral (I/O) Devices</b>	Go to page 24

---

## Installing the Mainboard in a Case

Refer to the following illustration and instructions for installing the mainboard in a case:

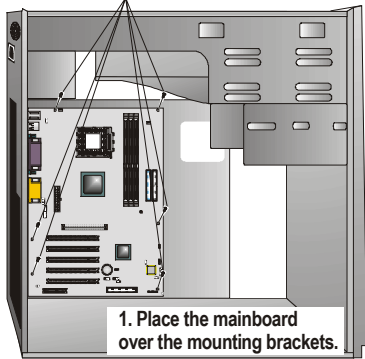
<p>This illustration shows an example of a mainboard being installed in a tower-type case:</p> <p><b>Note:</b> Do not overtighten the screws as this can stress the mainboard.</p> <p>Most system cases have mounting brackets installed in the case, which correspond to the holes in the mainboard. Place the mainboard over the mounting brackets and secure the mainboard onto the mounting brackets with screws.</p>	<p><b>2. Secure the mainboard with screws where appropriate.</b></p>  <p><b>1. Place the mainboard over the mounting brackets.</b></p>
---	--

Ensure that your case has an I/O template that supports the I/O ports and expansion slots on your mainboard.

---

## Checking Jumper Settings

This section explains how to set jumpers for correct configuration of the mainboard.

### Setting Jumpers

Use the mainboard jumpers to set system configuration options. Jumpers with more than one pin are numbered. When setting the jumpers, ensure that the jumper caps are placed on the correct pins.

The illustrations below show a 2-pin jumper. When the jumper cap is placed on both pins, the jumper is SHORT. If you remove the jumper cap, or place the jumper cap on just one pin, the jumper is OPEN.

This illustration shows a 3-pin jumper. Pins 1 and 2 are SHORT.

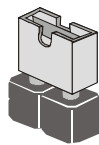

Short

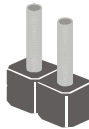

Open

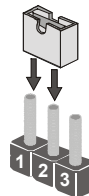



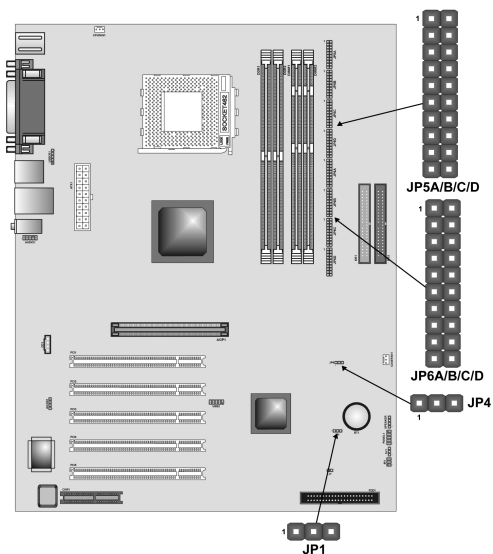

## Checking Jumper Settings

The following illustration shows the location of the mainboard jumpers. Pin 1 is labeled.



## Jumper Settings

Jumper	Type	Description	Setting (default)
JP1	3 pin	Clear CMOS	1-2: Normal 2-3: Clear 
JP4	3 pin	CPU frequency select	1-2: 100MHz 2-3: 133 MHz 
JP5A JP5B JP5C JP5D	80 pin	DDR/SDR DRAM Type Selector	Short all JP5A/B/C/D: DDR memory  Open all JP5A/B/C/D: SDR memory 

JP6A JP6B JP6C JP6D	80 pin	DDR/SDR DRAM Type Selector	<i>Short all JP6A/B/C/D: DDR memory</i>  <i>Open all JP6A/B/C/D: SDR memory</i>	<b>JP6A/B/C/D</b> 
------------------------------	--------	----------------------------------	---	--

**Jumper 1** – enables you to clear the BIOS. Follow these instructions:

1. Turn the system off.
2. Short pins 2 and 3 on JP1.
3. Return the jumper to the normal setting.
4. Turn the system on. The BIOS is returned to the default settings.

**Jumper 4** – set the CPU frequency (100MHz or 133MHz) according to the CPU.

**Jumper 5A/B/C/D** - this jumper enables the DDR terminator for DDR memory. If you installed DDR memory in DDR1/DDR2, short all the jumpers. Otherwise, if you installed SDR memory in DIMM1/DIMM2, open all the jumpers.

**Jumper 6A/B/C/D** - this jumper enables the DDR terminator for DDR memory. If you installed DDR memory in DDR1/DDR2, short all the jumpers. Otherwise, if you installed SDR memory in DIMM1/DIMM2, open all the jumpers.

## Connecting Case Components

After you have installed the mainboard into a case, you can begin connecting the mainboard components. Refer to the following:

1. Connect the case power supply connector to **ATX1**.
2. Connect the CPU cooling fan cable to **CPUFAN1**.
3. Connect the case cooling fan connector to **CASEFAN1**.
4. Connect the case speaker cable to **SPEAKER1**.
5. Connect the case LED cable to **SJ1**.
6. If your case has a case open alarm cable, connect it to **J1**.
7. Connect the case switches and indicator to **PANEL1**.

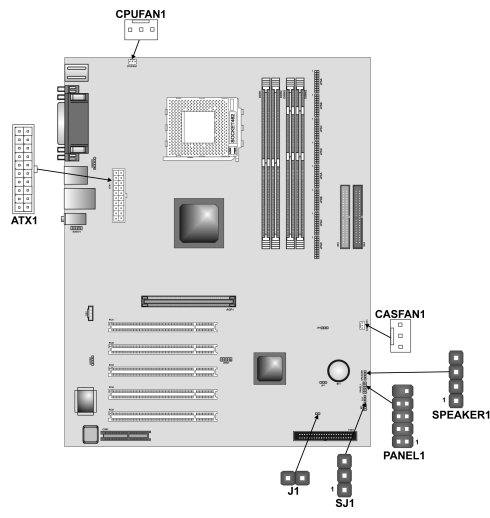

### CPUFAN1/CASEFAN1: FAN Power Connectors

Pin	Signal Name	Function
1	GND	System Ground
2	+12V	Power +12V
3	Sense	Sensor

### ATX1: ATX 20-pin Power Connector

Pin	Signal Name	Pin	Signal Name
1	+3.3V	11	+3.3V
2	+3.3V	12	-12V
3	Ground	13	Ground
4	+5V	14	PS ON#
5	Ground	15	Ground
6	+5V	16	Ground
7	Ground	17	Ground
8	PWRGD	18	-5V
9	+5VSB	19	+5V
10	+12V	20	+5V

**SPEAKER1: Internal speaker**

Pin	Signal Name
1	Signal
2	NC
3	Ground
4	VCC

**J1: Case open detecting connector** *(optional)*

This connector allows the user to detect unauthorized intrusion to the case. It will alert the user with a warning message when the case is turned on.

Pin	Signal Name	Function
1	Intruder	Case open detecting signal
2	GND	Ground

**SJ1: Single color LED header**

Pin	Signal Name	Function
1	ACPI LED	MSG LED (-) green
2	ACPI LED	MSG LED (-) green
3	SB5V	Power LED (+)

**LED function:**

SJ1  1	S0	S1	S3	S4/S5
	Light	Blinking	Blinking	Dark

## Front Panel Connector

The front panel connector (PANEL1) provides a standard set of switch and LED connectors commonly found on ATX or micro-ATX cases. Refer to the table below for information:

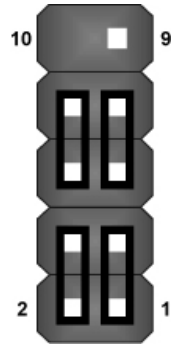

PANEL1

Pin	Function	Pin	Function
1	Hard disk LED (positive)	2	MSG LED [dual color or single color (+)]
3	Hard disk active LED (negative)	4	MSG LED [dual color or single color (-)]
5	Reset Switch	6	Power Switch
7	Reset Switch	8	Power Switch
9	Reserved	10	No pin

### Hard Drive Activity LED

Connecting pins 1 and 3 to a front panel mounted LED provides visual indication that data is being read from or written to the hard drive. For the LED to function properly, an IDE drive should be connected to the onboard IDE interface.

### Power / Sleep LED

Connecting pins 2 and 4 to a single- or dual-color, front panel mounted LED provides power on/off, sleep, and message waiting indication.

S0	S1	S3	S4/S5
Green	Green blinking	Yellow blinking	Dark

### Reset Switch

Supporting the reset function requires connecting pins 5 and 7 to a momentary-contact switch that is normally open. When the switch is closed, the board resets and runs POST.

### Power Switch

Supporting the power on/off function requires connecting pins 6 and 8 to a momentary-contact switch that is normally open. The switch should maintain contact for at least 50 ms to signal the power supply to switch on or off. The time requirement is due to internal debounce circuitry. After receiving a power on/off signal, at least two seconds elapses before the power supply recognizes another on/off signal.

---

## Installing Hardware

### Installing the Processor

**Caution:** When installing a CPU heatsink and cooling fan make sure that you **DO NOT** scratch the mainboard or any of the surface-mount resistors with the clip of the cooling fan. If the clip of the cooling fan scrapes across the mainboard, you may cause serious damage to the mainboard or its components.

On most mainboards, there are small surface-mount resistors near the processor socket, which may be damaged if the cooling fan is carelessly installed.

Avoid using cooling fans with sharp edges on the fan casing and the clips. Also, install the cooling fan in a well-lit work area so that you can clearly see the mainboard and processor socket.

### Before installing the Processor

This mainboard automatically determines the CPU clock frequency and system bus frequency for the processor. You may be able to change these settings by making changes to jumpers on the mainboard, or changing the settings in the system Setup Utility. We strongly recommend that you do not overclock processors or other components to run faster than their rated speed.

**Warning:** Overclocking components can adversely affect the reliability of the system and introduce errors into your system. Overclocking can permanently damage the mainboard by generating excess heat in components that are run beyond the rated limits.

This mainboard has a Socket 462 processor socket. When choosing a processor, consider the performance requirements of the system. Performance is based on the processor design, the clock speed and system bus frequency of the processor, and the quantity of internal cache memory and external cache memory.

## CPU Installation Procedure

The following illustration shows CPU installation components:

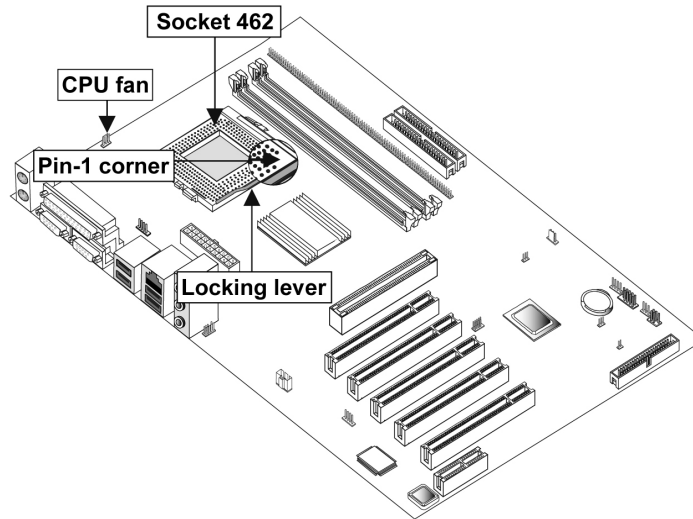

---

**Note:** The pin-1 corner is marked with an arrow ▼

---

Follow these instructions to install the CPU:

1. Pull the CPU socket locking lever away from the socket to unhook it and raise the locking lever to the upright position.
2. Match the corner on the CPU marked with an arrow with pin A-1 on the CPU socket (the corner with the pinhole noticeably missing). Insert the processor into the socket. Do not use force.
3. Swing the locking lever down and hook it under the latch on the edge of the socket.
4. Apply thermal grease to the top of the CPU.
5. Lower the CPU cooling fan/heatsink assembly onto the CPU
6. Secure the two retention clips on either side of the fan/heatsink unit onto the Socket 462 base.

A diagram showing a fan/heatsink unit being lowered onto a CPU. A dashed arrow points from the unit to the CPU. Below the diagram, the text reads: 'Fan/heatsink unit secured to socket'.

7. Connect the CPU Cooling Fan power cable connector to the CPUFAN connector.

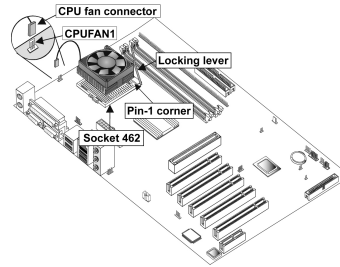

- Notes:**
- To achieve better airflow rates and heat dissipation, we suggest that you use a high quality fan with 4800 rpm at least.
  - CPU fan and heatsink installation procedures may vary with the type of CPU fan/heatsink supplied. The form and size of fan/heatsink may also vary.

## Installing Memory Modules

This mainboard accommodates 184-pin 2.5V Double Data Rate (DDR) SDRAM and 168-pin 3.3V SDRAM memory modules. The memory chips must be standard SDRAM (Synchronous Dynamic Random Access Memory).

The CPU supports 100MHz system bus. The SDRAM DIMMs and DDRs can synchronously work with 100 MHz or operates over a 133 MHz system bus.



Do not remove any memory module from its antistatic packaging until you are ready to install it on the mainboard. Handle the modules only by their edges. Do not touch the components or metal parts. Always wear a grounding strap when you handle the modules.

## Installation Procedure

You must install at least one memory module in order to use the mainboard. Each module can be installed with up to 1 GB of memory; total memory capacity is 2GB.

**Note:** You cannot use DDR SDRAM and SDRAM simultaneously.

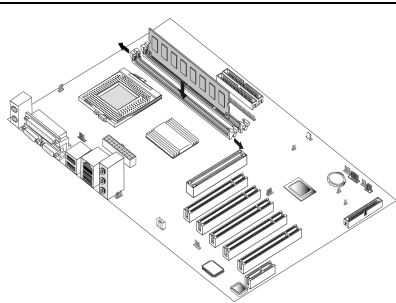

SDRAM provides 800 MBps or 1 GBps data transfer depending on whether the bus is 100 MHz or 133 MHz. Double Data Rate SDRAM (DDR SDRAM) doubles the rate to 1.6 GBps or 2.1 GBps by transferring data on both the rising and falling edges of the clock. DDR SDRAM uses additional power and ground lines and requires 184-pin DIMM modules rather than the 168-pin DIMMs used by SDRAM.

Refer to the following to install the memory modules.

1. Push the latches on each side of the DIMM slot down.
2. Align the memory module with the slot. The DIMM slots are keyed with notches and the DIMMs are keyed with cutouts so that they can only be installed correctly.
3. Check that the cutouts on the DIMM module edge connector match the notches in the DIMM slot:

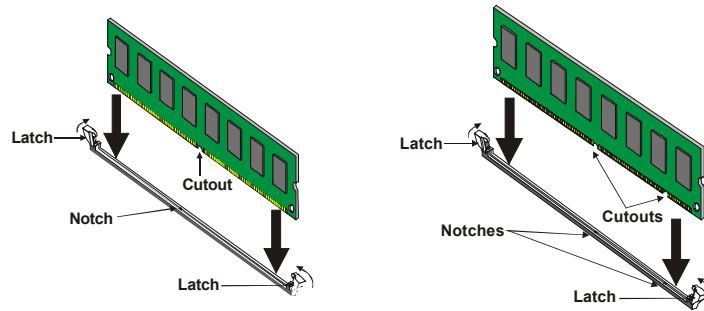

**DDR SDRAM Module**

**SDRAM Module**

4. Install the DIMM module into the slot and press it firmly down until it seats correctly. The slot latches are levered upwards and latch on to the edges of the DIMM.
5. Install any remaining DIMM modules.

## Installing a Hard Disk Drive/CD-ROM

This section describes how to install IDE devices such as a hard disk drive and a CD-ROM drive.

### About IDE Devices

Your mainboard has a primary and secondary IDE channel interface (IDE1 and IDE2). An IDE ribbon cable supporting two IDE devices is bundled with the mainboard.

If you want to install more than two IDE devices, get a second IDE cable and you can add two more devices to the secondary IDE channel.

IDE devices have jumpers or switches that are used to set the IDE device as MASTER or SLAVE. Refer to the IDE device user's manual. When installing two IDE devices on one cable, ensure that one device is set to MASTER and the other device is set to SLAVE. The documentation of your IDE device explains how to do this.

### About UltraDMA

This mainboard supports UltraDMA 66/100/133. UDMA is a technology that accelerates the performance of devices in the IDE channel. To maximize performance, install IDE devices that support UDMA and use 80-pin IDE cables that support UDMA 66/100/133.

## Installing a Hard Disk Drive

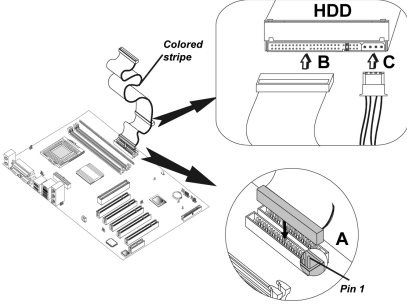
<ol style="list-style-type: none"><li>1. Install the hard disk drive into the drive cage in your system case.</li><li>2. Plug the IDE cable into IDE1 (A):</li></ol> <p><b>Note:</b> Ribbon cable connectors are usually keyed so that they can only be installed correctly on the device connector. If the connector is not keyed, make sure that you match the pin-1 side of the cable connector with the pin-1 side of the device connector. Each connector has the pin-1 side clearly marked. The pin-1 side of each ribbon cable is always marked with a colored stripe on the cable.</p>	
<ol style="list-style-type: none"><li>3. Plug an IDE cable connector into the hard disk drive IDE connector (B). It doesn't matter which connector on the cable you use.</li><li>4. Plug a power cable from the case power supply into the power connector on the hard disk drive (C).</li></ol>	

When you first start up your system, the BIOS should automatically detect your hard disk drive. If it doesn't, enter the Setup Utility and use the IDE Hard Disk Auto Detect feature to configure the hard disk drive that you have installed. See IDE HDD Auto-Detection on page 30 for more information.

## Installing a CD-ROM/DVD Drive

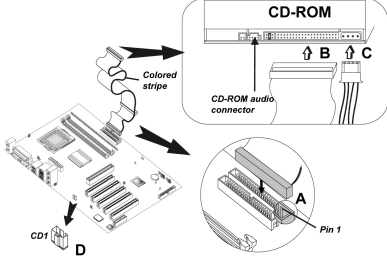
1. Install the CD-ROM/DVD drive into the drive cage in your system case.	
<p>2. Plug the IDE cable into IDE1 (A). If you have already installed an HDD, use the other connector on the IDE cable.</p> <p><b>Note:</b> Ribbon cable connectors are usually keyed so that they can only be installed correctly on the device connector. If the connector is not keyed, make sure that you match the pin-1 side of the cable connector with the pin-1 side of the device connector. Each connector has the pin-1 side clearly marked. The pin-1 side of each ribbon cable is always marked with a colored stripe on the cable.</p>	
3. Plug an IDE cable connector into the CD-ROM/DVD drive IDE connector (B). It doesn't matter which connector on the cable you use.	
4. Plug a power cable from the case power supply into the power connector on the CD-ROM/DVD drive (C).	
5. Use the audio cable provided with the CD-ROM/DVD drive to connect to the mainboard CD-in connector CD1 (D).	

When you first start up your system, the BIOS should automatically detect your CD-ROM/DVD drive. If it doesn't, enter the Setup Utility and configure the CD-ROM/DVD drive that you have installed. See IDE Primary/Secondary Master/Slave (Auto) on page 30 for more information.

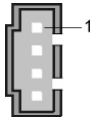

**CD1**

Pin	Signal Name
1	CD IN L
2	GND
3	GND
4	CD IN R

## Installing a Floppy Diskette Drive

The mainboard has a floppy diskette drive (FDD) interface and ships with a diskette drive ribbon cable that supports one or two floppy diskette drives. You can install a 5.25-inch drive and a 3.5-inch drive with various capacities. The floppy diskette drive cable has one type of connector for a 5.25-inch drive and another type of connector for a 3.5-inch drive.

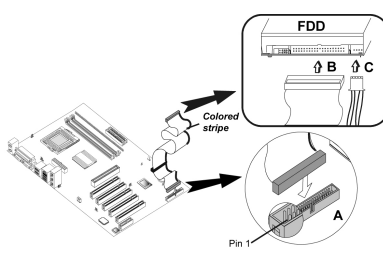
<p>1. Install the FDD into the drive cage in your system case.</p> <p>2. Plug the FDD cable into FDD1 (A):</p> <p><b>Note:</b> Ribbon cable connectors are usually keyed so that they can only be installed correctly on the device connector. If the connector is not keyed, make sure that you match the pin-1 side of the cable connector with the pin-1 side of the device connector. Each connector has the pin-1 side clearly marked. The pin-1 side of each ribbon cable is always marked with a colored stripe on the cable.</p>	
<p>3. Plug the correct connector on the FDD cable for the 5.25-inch or 3.5-inch drive into the FDD connector (B).</p>	
<p>4. Plug a power cable from the case power supply into the power connector on the FDD (C).</p>	

When you first start up your system, go immediately to the Setup Utility to configure the floppy diskette drives that you have installed.

## Installing Add-on Cards

The slots in this mainboard are designed to hold expansion cards and connect them to the system bus. Expansion slots are a means of adding or enhancing the mainboard's features and capabilities. With these efficient facilities, you can increase the mainboard's capabilities by adding hardware which performs tasks that are not part of the basic system.

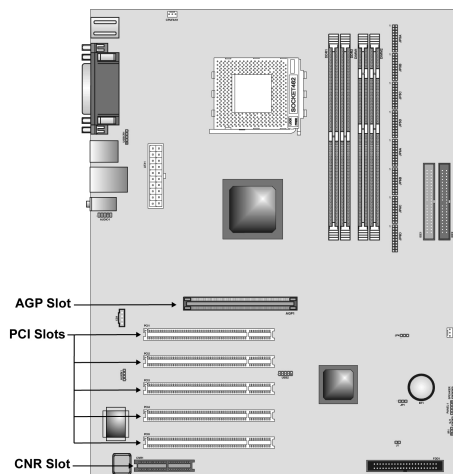

### PCI Slots

PCI slots are used to install expansion cards that have the 32-bit PCI interface.

### AGP Slot

The AGP slot is used to install a graphics adapter that supports the 4xAGP specification and has a 4xAGP edge connector.

---

**Note:** The above layout is for reference only. The AGP slot may be different from your mainboard. Please refer to actual shipment.

---

### CNR Slot

This slot is used to insert CNR cards with Modem and Audio functionality.

---

**Note:** Before installing an add-on card, check the documentation for the card carefully. If the card is not Plug and Play, you may have to manually configure the card before installation.

---

Follow these instructions to install an add-on card:

1. Remove a blanking plate from the system case corresponding to the slot you are going to use.

2. Install the edge connector of the add-on card into the expansion slot. Ensure that the edge connector is correctly seated in the slot.

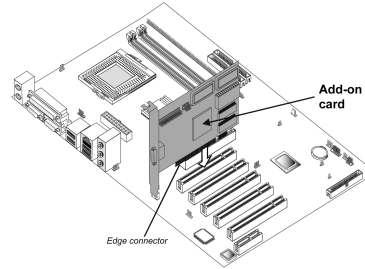

3. Secure the metal bracket of the card to the system case with a screw.

**Note:** For some add-on cards, for example graphics adapters and network adapters, you have to install drivers and software before you can begin using the add-on card.

## Connecting Optional Devices

Refer to the following for information on connecting the mainboard's optional devices:

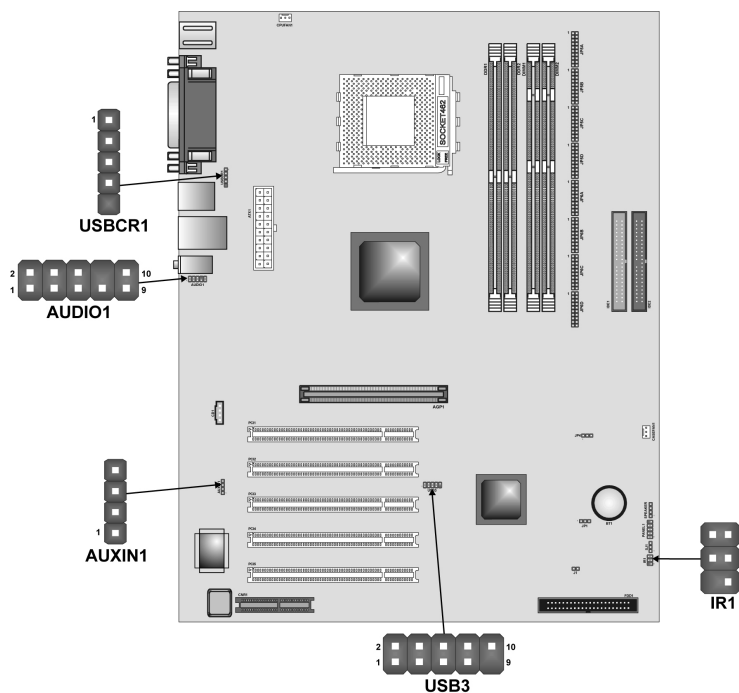

### AUDIO1: Front Panel Audio header

This header allows the user to install auxiliary front-oriented microphone and line-out ports for easier access.

Pin	Signal Name	Function
1	AUD_MIC	Front Panel Microphone input signal
2	AUD_GND	Ground used by Analog Audio Circuits
3	AUD_MIC_BIAS	Microphone Power
4	AUD_VCC	Filtered +5 V used by Analog Audio Circuits
5	AUD_FPOUT_R	Right Channel Audio signal to Front Panel
6	AUD_RET_R	Right Channel Audio signal to Return from Front Panel
7	HP_ON	Reserved for future use to control Head-phone Amplifier
8	KEY	No Pin
9	AUD_FPOUT_L	Left Channel Audio signal to Front Panel
10	AUD_RET_L	Left Channel Audio signal Return from Front Panel

## USB3: Front panel USB connectors

The mainboard has four USB ports installed on the rear edge I/O port array. Additionally, some computer cases have USB ports at the front of the case. If you have this kind of case, use auxiliary USB connectors USB3 to connect the front-mounted ports to the mainboard.

Pin	Signal Name	Function
1	USBVCC3	+5V dual
2	USBVCC3	+5V dual
3	USBP4-	Data signal port 4 -
4	USBP5-	Data signal port 5 -
5	USBP4+	Data signal port 4 +
6	USBP5+	Data signal port 5 +
7	GND	Ground
8	GND	Ground
9	Key	Cut away
10	NC	No connection

**Note:** Please make sure that the USB cable has the same pin assignment as indicated above. A different pin assignment may cause damage or system hang-up.

## IR1: Infrared port

The infrared port allows the wireless exchange of information between your computer and similarly equipped devices such as printers, laptops, Personal Digital Assistants (PDAs), and other computers.

Pin	Signal Name	Function
1	Not assigned	Not assigned
2	KEY	No pin
3	+5V	IR Power
4	GND	Ground
5	IRTX	IrDA serial output
6	IRRX	IrDA serial input

## AUXIN1: Extra line-in connector

This connector is an additional line-in audio connector. It allows you to attach a line-in cable when your rear line-in jack is set as line out port for 4-channel function.

Pin	Signal Name	Function
1	AUX_L	AUX In left channel
2	GND	Ground
3	GND	Ground
4	AUX_R	AUX In right channel

## USBCR1: USB Card Reader connector

This connector is for connecting internal USB card reader. You can use a card reader to read or transfer files and digital images to your computer.

Pin	Signal Name	Function
1	USBVCC2	+5V dual
2	USB2-	Data signal port 2-
3	USB2+	Data signal port 2+
4	GND	Ground
5	Key	No pin

**Note:** The USBCR1 is shared with one of the USB ports of the I/O back panel. The USB port is located beside the serial port connectors. See “Connecting I/O Devices” for more information.

## Connecting I/O Devices

The backplane of the mainboard has the following I/O ports:

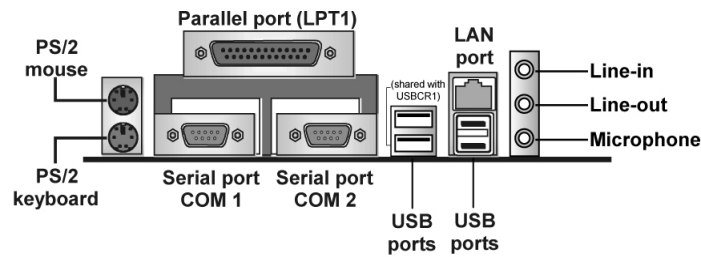

<b>PS/2 Mouse</b>	Use the upper PS/2 port to connect a PS/2 pointing device.
<b>PS/2 Keyboard</b>	Use the lower PS/2 port to connect a PS/2 keyboard.
<b>LPT1</b>	Use LPT1 to connect printers or other parallel communications devices.
<b>COM1/2</b>	Use the COM ports to connect serial devices such as mice or fax/modems. COM1 is identified by the system as COM1/3. COM2 is identified by the system as COM2/4.
<b>Audio Ports</b>	Use the three audio ports to connect audio devices. The first jack is for stereo line-in signal. The second jack is for stereo line-out signal. The third jack is for microphone.
	<b>Note:</b> The line-in port can be set as another line-out port when the 4-channel function is enabled.
<b>LAN Port (optional)</b>	Connect an RJ-45 jack to the LAN port to connect your computer to the Network.
<b>USB Ports</b>	Use the USB ports to connect USB devices.
	<b>Note:</b> The second USB port located beside the serial COM 2 port is shared with the USBCR1 connector.

## External Connector Color Coding

Many connectors now use standard colors as shown in the table below.

Connector	Color
Audio line-in	Light blue
Audio line-out	Lime
Microphone	Pink
Parallel	Burgundy
PS/2-compatible keyboard	Purple
PS/2-compatible mouse	Green
Serial	Teal or Turquoise
USB	Black

This concludes Chapter 2. The next chapter covers the BIOS.

## *Chapter 3*

# Using BIOS

---

### **About the Setup Utility**

The computer uses the latest Award BIOS with support for Windows Plug and Play. The CMOS chip on the mainboard contains the ROM setup instructions for configuring the mainboard BIOS.

The BIOS (Basic Input and Output System) Setup Utility displays the system's configuration status and provides you with options to set system parameters. The parameters are stored in battery-backed-up CMOS RAM that saves this information when the power is turned off. When the system is turned back on, the system is configured with the values you stored in CMOS.

The BIOS Setup Utility enables you to configure:

- Hard drives, diskette drives, and peripherals
- Video display type and display options
- Password protection from unauthorized use
- Power management features

The settings made in the Setup Utility affect how the computer performs. Before using the Setup Utility, ensure that you understand the Setup Utility options.

This chapter provides explanations for Setup Utility options.

### **The Standard Configuration**

A standard configuration has already been set in the Setup Utility. However, we recommend that you read this chapter in case you need to make any changes in the future.

This Setup Utility should be used:

- when changing the system configuration
- when a configuration error is detected and you are prompted to make changes to the Setup Utility
- when trying to resolve IRQ conflicts
- when making changes to the Power Management configuration
- when changing the password or making other changes to the Security Setup

## Starting Setup

The BIOS is immediately activated when you first turn on the computer. The BIOS reads system configuration in CMOS RAM and begins the process of checking out the system and configuring it through the power-on self test (POST).

When these preliminaries are finished, the BIOS seeks an operating system on one of the data storage devices (hard drive, floppy drive, etc.). The BIOS launches the operating system and hands control of system operations to it.

During POST, you can start the Setup program in one on two ways:

1. By pressing Del immediately after switching the system on, or
2. By pressing Del or pressing Ctrl+Alt+Esc when the following message appears briefly at the bottom of the screen during POST:

TO ENTER SETUP BEFORE BOOT PRESS DEL KEY

*If the message disappears before you respond and you still wish to enter Setup, restart the system to try again by turning it OFF then ON or pressing the RESET button on the system case. You may also restart by simultaneously pressing Ctrl+Alt+Del. If you do not press the keys at the correct time and the system does not boot, an error message appears and you are again asked to:*

PRES F1 TO CONTINUE, DEL TO ENTER SETUP

Phoenix – AwardBIOS CMOS Setup Utility

▶ <b>Standard CMOS Features</b>	▶ <b>Frequency Control</b>
▶ <b>Advanced BIOS Features</b>	Load Fail-Safe Defaults
▶ <b>Advanced Chipset Features</b>	Load Optimized Defaults
▶ <b>Integrated Peripherals</b>	Set Supervisor Password
▶ <b>Power Management Setup</b>	Set User Password
▶ <b>PnP/PCI Configurations</b>	Save & Exit Setup
▶ <b>PC Health Status</b>	Exit Without Saving
Esc : Quit	↑ ↓ → ← : Select Item
F10 : Save & Exit Setup	
Time, Date, Hard Disk Type . . .	

## BIOS Navigation Keys

The BIOS navigation keys are listed below:

Key	Function
Esc	Exits the current menu
←↑↓→	Scrolls through the items on a menu
+/-/PU/PD	Modifies the selected field's values
F10	Saves the current configuration and exits setup
F1	Displays a screen that describes all key functions
F5	Loads previously saved values to CMOS
F6	Loads a minimum configuration for troubleshooting.
F7	Loads an optimum set of values for peak performance

## Updating the BIOS

You can download and install updated BIOS for this mainboard from the manufacturer's Web site. New BIOS provides support for new peripherals, improvements in performance, or fixes for known bugs. Install new BIOS as follows:

1. If your mainboard has a BIOS protection jumper, change the setting to allow BIOS flashing.
2. If your mainboard has an item called Firmware Write Protect in Advanced BIOS features, disable it. (Firmware Write Protect prevents BIOS from being overwritten.)
3. Create a bootable system disk. (Refer to Windows online help for information on creating a bootable system disk.)
4. Download the Flash Utility and new BIOS file from the manufacturer's Web site. Copy these files to the system diskette you created in Step 3.
5. Turn off your computer and insert the system diskette in your computer's diskette drive. (You might need to run the Setup Utility and change the boot priority items on the Advanced BIOS Features Setup page, to force your computer to boot from the floppy diskette drive first.)
6. At the A:\ prompt, type the Flash Utility program name and press <Enter>. You see a screen similar to the following:

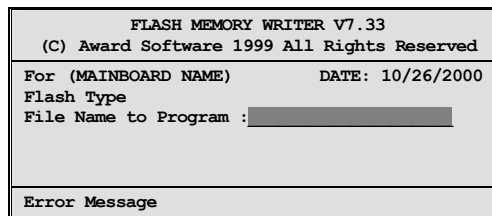

7. Type the filename of the new BIOS in the "File Name to Program" text box. Follow the onscreen directions to update the mainboard BIOS.

8. When the installation is complete, remove the floppy diskette from the diskette drive and restart your computer. If your mainboard has a Flash BIOS jumper, reset the jumper to protect the newly installed BIOS from being overwritten.

## Using BIOS

When you start the Setup Utility, the main menu appears. The main menu of the Setup Utility displays a list of the options that are available. A highlight indicates which option is currently selected. Use the cursor arrow keys to move the highlight to other options. When an option is highlighted, execute the option by pressing <Enter>.

Some options lead to pop-up dialog boxes that prompt you to verify that you wish to execute that option. Other options lead to dialog boxes that prompt you for information.

Some options (marked with a triangle ►) lead to submenus that enable you to change the values for the option. Use the cursor arrow keys to scroll through the items in the submenu.

In this manual, default values are enclosed in parenthesis. Submenu items are denoted by a triangle ►.

## Standard CMOS Features

*In the Standard CMOS menu you can set the system clock and calendar, re-record disk drive parameters and the video subsystem type, and select the type of errors that stop the BIOS POST.*

Phoenix – AwardBIOS CMOS Setup Utility  
Standard CMOS Features

		Item Help
Date (mm:dd:yy)	Tue, July 11 2001	Menu Level ► Change the day, month, year and century.
Time (hh:mm:ss)	12 : 8 : 59	
► IDE Primary Master		
► IDE Primary Slave		
► IDE Secondary Master		
► IDE Secondary Slave		
Drive A	[1.44M, 3.5 in.]	
Drive B	[None]	
Video	[EGA/VGA]	
Halt On	[All errors]	
Base Memory	640K	
Extended Memory	31744K	
Total Memory	32768K	

↑ ↓ → ← : Move    Enter : Select    +/-/PU/PD:Value:    F10: Save    ESC: Exit    F1:General Help  
F5:Previous Values    F6:Fail-Safe Defaults    F7:Optimized Defaults

### Date and Time

The Date and Time items show the current date and time on the computer. If you are running a Windows OS, these items are automatically updated whenever you make changes to the Windows Date and Time Properties utility.

### ► IDE Devices(None)

Your computer has two IDE channels (Primary and Secondary) and each channel can be installed with one or two devices (Master and Slave). Use these items to configure each device on the IDE channel.

Press <Enter> to display the IDE submenu:

CMOS Setup Utility – Copyright © 1984 – 2001 Award Software  
IDE Primary Master

IDE HDD Auto-Detection	[Press Enter]	Item Help
IDE Primary Master	[Auto]	Menu Level ►►
Access Mode	[Auto]	To auto-detect the HDD's size, head . . . on this channel
Capacity	0 MB	
Cylinder	0	
Head	0	
Precomp	0	
Landing Zone	0	
Sector	0	

↑↓→← : Move    Enter : Select    +/-/PU/PD:Value:    F10: Save    ESC: Exit    F1:General Help  
F5:Previous Values    F6:Fail-Safe Defaults    F7:Optimized Defaults

#### **IDE HDD Auto-Detection**

Press <Enter> while this item is highlighted to prompt the Setup Utility to automatically detect and configure an IDE device on the IDE channel.

---

**Note:** If you are setting up a new hard disk drive that supports LBA mode, more than one line will appear in the parameter box. Choose the line that lists LBA for an LBA drive.

---

#### **IDE Primary/Secondary Master/Slave (Auto)**

Leave this item at Auto to enable the system to automatically detect and configure IDE devices on the channel. If it fails to find a device, change the value to Manual and then manually configure the drive by entering the characteristics of the drive in the items described below.

Refer to your drive's documentation or look on the drive casing if you need to obtain this information. If no device is installed, change the value to None.

---

**Note:** Before attempting to configure a hard disk drive, ensure that you have the configuration information supplied by the manufacturer of your hard drive. Incorrect settings can result in your system not recognizing the installed hard disk.

---

#### **Access Mode**

This item defines ways that can be used to access IDE hard disks such as LBA (Large Block Addressing). Leave this value at Auto and the system will automatically decide the fastest way to access the hard disk drive.

Press <Esc> to return to the Standard CMOS Features screen.

### Drive A/DriveB (1.44M, 3.5 in./None)

These items define the characteristics of any diskette drive attached to the system. You can connect one or two diskette drives.

### Video (EGA/VGA)

This item defines the video mode of the system. This mainboard has a built-in VGA graphics system; you must leave this item at the default value.

### Halt On (All, But keyboard)

This item defines the operation of the system POST (Power On Self Test) routine. You can use this item to select which types of errors in the POST are sufficient to halt the system.

### Base Memory, Extended Memory, and Total Memory

These items are automatically detected by the system at start up time. These are display-only fields. You cannot make changes to these fields.

## Advanced BIOS Setup

*This screen contains industry-standard options additional to the core PC AT BIOS.*

Phoenix – AwardBIOS CMOS Setup Utility  
Advanced BIOS Setup

CPU Internal Cache	[Enabled]	▲                               ▼	Item Help
External Cache	[Enabled]		Menu Level ▶
CPU L2 Cache ECC Checking	[Enabled]		Allows you to choose the VIRUS warning feature for IDE Hard Disk boot sector protection. If this function is enabled and someone attempts to write data into this area, BIOS will show a warning message on screen and alarm beep
Quick Power On Self Test	[Enabled]		
First Boot Device	[Floppy]		
Second Boot Device	[HDD-0]		
Third Boot Device	[CD-ROM]		
Boot Other Device	[Enabled]		
Swap Floppy Drive	[Disabled]		
Boot Up Floppy Seek	[Enabled]		
Boot Up NumLock Status	[On]		
Gate A20 Option	[Fast]		
ATA 66/100 IDE Cable Msg	[Enabled]		
Typematic Rate Setting	[Disabled]		
x Typematic Rate (Chars/Sec)	6		
x Typematic Delay (Msec)	250		
Security Option	[Setup]		
APIC Mode	[Disabled]		

↑ ↓ → ← : Move    Enter : Select    +/-/PU/PD: Value:    F10: Save    ESC: Exit    F1: General Help  
F5: Previous Values    F6: Fail-Safe Defaults    F7: Optimized Defaults

### CPU Internal Cache (Enabled)

All processors that can be installed in this mainboard use internal level 1 (L1) cache memory to improve performance. Leave this item at the default value for better performance.

### External Cache (Enabled)

Most processors that can be installed in this system use external level 2 (L2) cache memory to improve performance. Leave this item at the default value

for better performance.

**CPU L2 Cache ECC Checking(Enabled)**

This item enables or disables ECC (Error Correction Code) error checking on the CPU cache memory. We recommend that you leave this item at the default value.

**Quick Power On Self Test (Enabled)**

Enable this item to shorten the power on testing (POST) and have your system start up faster. You might like to enable this item after you are confident that your system hardware is operating smoothly.

**First/Second/Third Boot Device (Floppy/HDD0/CD-ROM)**

Use these three items to select the priority and order of the devices that your system searches for an operating system at start-up time.

**Boot Other Device(Enabled)**

When enabled, the system searches all other possible locations for an operating system if it fails to find one in the devices specified under the First, Second, and Third boot devices.

**Swap Floppy Drive (Disabled)**

If you have two floppy diskette drives in your system, this item allows you to swap the assigned drive letters so that drive A becomes drive B, and drive B becomes drive A.

**Boot Up Floppy Seek (Enabled)**

If this item is enabled, it checks the size of the floppy disk drives at start-up time. You don't need to enable this item unless you have a legacy diskette drive with 360K capacity.

**Boot Up NumLockStatus(On)**

This item defines if the keyboard Num Lock key is active when your system is started.

**Gate A20 Option(Fast)**

This item defines how the system handles legacy software that was written for an earlier generation of processors. Leave this item at the default value.

**ATA 66/100 IDE Cable Msg (Enabled)**

Enables or disables the ATA 66/100 IDE Cable Msg. This message will appear during reboot when you use 40-pin cable on your 66/100 hard disks.

**TypematicRate Setting(Disabled)**

If this item is enabled, you can use the following two items to set the typematic rate and the typematic delay settings for your keyboard.

- **Typematic Rate (Chars/Sec):** Use this item to define how many characters per second are generated by a held-down key.
- **Typematic Delay (Msec):** Use this item to define how many milliseconds must elapse before a held-down key begins generating repeat characters.

### Security Option (Setup)

If you have installed password protection, this item defines if the password is required at system start up, or if it is only required when a user tries to enter the Setup Utility.

### APIC Mode (Enabled)

Selecting Enabled enables the ACPI device mode reporting from the BIOS to the operating system.

### OS Select For DRAM > 64 MB (Non-OS2)

This item is only required if you have installed more than 64 MB of memory and you are running the OS/2 operating system. Otherwise, leave this item at the default.

### Video BIOS Shadow (Enabled)

This function, when enabled allows VGA BIOS to be copied to the system DRAM for enhanced performance.

### Small Logo (EPA) Show (Disabled)

Determines whether or not the EPA logo appears during boot up.

## Advanced Chipset Setup

*The parameters in this screen are for system designers, service personnel, and technically competent users only. Do not reset these values unless you understand the consequences of your changes.*

Phoenix – AwardBIOS CMOS Setup Utility  
Advanced Chipset Setup

▶ DRAM Clock/Drive Control	[Press Enter]	Item Help
▶ AGP & P2P Bridge Control	[Press Enter]	
▶ CPU & PCI Bus Control	[Press Enter]	Menu Level ▶
Memory Hole	[Disabled]	
System BIOS Cacheable	[Disabled]	
Video RAM Cacheable	[Disabled]	

↑↓ → ← : Move    Enter : Select    +/-/PU/PD: Value:    F10: Save    ESC: Exit    F1: General Help  
F5: Previous Values    F6: Fail-Safe Defaults    F7: Optimized Defaults

► **DRAMClock/DriveControl**

Scroll to this item and press <Enter> to view the following screen:

CMOS Setup Utility – Copyright (C) 1984 – 2001 Award Software  
DRAM Clock/Drive Control

Current FSB Frequency		Item Help
Current DRAM Frequency		
DRAM Clock	[By SPD]	Menu Level ►
DRAM Timing	[By SPD]	
x SDRAM Cycle Length	3	
x Bank Interleave	Disabled	
DRAM Command Rate	[2T Command]	

↑↓ : Move    ← : Move    Enter : Select    +/-/PU/PD:Value:    F10: Save    ESC: Exit    F1:General Help  
F5:Previous Values    F6:Fail-Safe Defaults    F7:Optimized Defaults

**Current FSB Frequency**

This item displays the frontside bus (FSB) frequency. This is a display-only item. You cannot make changes to this field.

**Current DRAM Frequency**

This item displays the memory (DRAM) frequency. This is a display-only item. You cannot make changes to this field.

**DRAM Clock (100 MHz)**

This item enables you to manually set the DRAM Clock. We recommend that you leave this item at the default value.

**DRAM Timing (Manual)**

Set this to the default value to enable the system to automatically set the SDRAM timing by SPD (Serial Presence Detect). SPD is an EEPROM chip on the DIMM module that stores information about the memory chips it contains, including size, speed, voltage, row and column addresses, and manufacturer. If you disable this item, you can use the following three items to manually set the timing parameters for the system memory

**SDRAM Cycle Length (3)**

When synchronous DRAM is installed, the number of clock cycles of CAS latency depends on the DRAM timing. We recommend that you leave this item at the default value.

**Bank Interleave (4 Bank)**

Enable this item to increase memory speed. When enabled, separate memory banks are set for odd and even addresses and the next byte of memory can be accessed while the current byte is being refreshed.

**DRAM Command Rate (2T Command)**

This item enables you to specify the waiting time for the CPU to issue the next

command after issuing the command to the DDR memory. We recommend that you leave this item at the default value.

#### **DRAM Burst Length (4)**

This item describes which burst lengths are supported by the devices on the mainboard. 1 level can provide faster performance but may result in instability whereas 8 level gives the most stable but slowest performance.

#### **DRAM Queue Depth (4 level)**

This item sets the depth of the DRAM queue used for CPU's cache.

Press <Esc> to return to the Advanced Chipset Setup screen.

#### **▶ AGP & P2P Bridge Control**

Scroll to this item and press <Enter> to view the following screen:

CMOS Setup Utility – Copyright (C) 1984 – 2001 Award Software  
AGP & P2P Bridge Control

AGP Aperture Size	[128M]	Item Help
AGP Mode	[4X]	
AGP Driving Control	[Auto]	
x AGP Driving Value	DA	Menu Level ▶

↑↓→← : Move Enter : Select +/-/PU/PD:Value: F10: Save ESC: Exit F1:General Help  
F5:Previous Values F6:Fail-Safe Defaults F7:Optimized Defaults

#### **AGP Aperture Size (128 MB)**

This item defines the size of the aperture if you use an AGP graphics adapter. The AGP aperture refers to a section of the PCI memory address range used for graphics memory. We recommend that you leave this item at the default value.

#### **AGP Mode (4X)**

This item allows you to enable or disable the caching of display data for the processor video memory. Enabling AGP-4X Mode can greatly improve the display speed. Disable this item if your graphics display card does not support this feature.

#### **AGP Driving Control (Auto)**

This item is used to signal driving current on AGP cards to auto or manual. Some AGP cards need stronger than normal driving current in order to operate. We recommend that you set this item to the default.

- **AGP Driving Value:** When AGP Driving Control is set to Manual, use this item to set the AGP current driving value.

Press <Esc> to return to the Advanced Chipset Setup screen.

► **CPU & PCI Bus Control**

Scroll to this item and press <Enter> to view the following screen:

CMOS Setup Utility – Copyright (C) 1984 – 2001 Award Software  
CPU & PCI Bridge Control

PCI1 Master 0 WS Write	[Enabled]	Item Help
PCI2 Master 0 WS Write	[Enabled]	
PCI1 Post Write	[Enabled]	Menu Level ►
PCI2 Post Write	[Enabled]	
PCI Delay Transaction	[Disabled]	

↑↓→← : Move Enter : Select +/-/PU/PD:Value: F10: Save ESC: Exit F1:General Help  
F5:Previous Values F6:Fail-Safe Defaults F7:Optimized Defaults

**PCI 1/2 Master 0 WS Write (Enabled)**

When enabled, writes to the PCI bus are executed with zero wait states, providing faster data transfer.

**PCI 1/2 Post Write (Enabled)**

When enabled, writes from the CPU to PCU bus are buffered, to compensate for the speed differences between the CPU and PCI bus. When disabled, the writes are not buffered and the CPU must wait until the write is complete before starting another write cycle.

**PCI Delay Transaction (Disabled)**

The mainboard's chipset has an embedded 32-bit post write buffer to support delay transactions cycles. Select Enabled to support compliance with PCI specification version 2.1.

Press <Esc> to return to the Advanced Chipset Setup screen.

**MemoryHole (Disabled)**

This item is used to reserve memory space for ISA expansion cards that require it.

**SystemBIOS/VideoRAM Cacheable(Disabled)**

These items allow the video and system to be cached in memory for faster execution. Leave these items at the default value for better performance.

## Integrated Peripherals

These options display items that define the operation of peripheral components on the system's input/output ports.

### Phoenix – AwardBIOS CMOS Setup Utility Integrated Peripherals

		Item Help
USB 2.0 Support	[Enabled]	
▶ OnChip IDE Device	[Press Enter]	Menu Level ▶
▶ OnChip PCI Device	[Press Enter]	
▶ Super I/O Device	[Press Enter]	
Init Display First	[PCI Slot]	
OnChip USB Controller	[All Enabled]	
USB keyboard Support	[Disabled]	
IDE HDD Block Mode	[Enabled]	
PWRON After PWR-Fail	[Off]	

↑↓→← : Move Enter : Select +/-/PU/PD:Value: F10: Save ESC: Exit F1:General Help  
F5:Previous Values F6:Fail-Safe Defaults F7:Optimized Defaults

### USB 2.0 Support(Enabled)

Select enabled if your system support the USB 2.0 function.

### ▶ OnChipIDE Device

Scroll to this item and press <Enter> to view the following screen:

### CMOS Setup Utility – Copyright (C) 1984 – 2001 Award Software OnChip IDE Device

		Item Help
OnChip IDE Channel0	[Enabled]	
OnChip IDE Channel1	[Enabled]	
IDE Prefetch Mode	[Enabled]	Menu Level ▶▶
Primary Master PIO	[Auto]	
Primary Slave PIO	[Auto]	
Secondary Master PIO	[Auto]	
Secondary Slave PIO	[Auto]	
Primary Master UDMA	[Auto]	
Primary Slave UDMA	[Auto]	
Secondary Master UDMA	[Auto]	
Secondary Slave UDMA	[Auto]	

↑↓→← : Move Enter : Select +/-/PU/PD:Value: F10: Save ESC: Exit F1:General Help  
F5:Previous Values F6:Fail-Safe Defaults F7:Optimized Defaults

### On-Chip IDE Channel 0/1 (Enabled)

Use these items to enable or disable the PCI IDE channels that are integrated on the mainboard.

**IDE Prefetch Mode (Enabled)**

The onboard IDE drive interfaces supports IDE prefetching, for faster drive access. If you install a primary and secondary add-in IDE interface, set this field to Disabled if the interface does not support prefetching.

**IDE Primary/Secondary Master/Slave PIO (Auto)**

Each IDE channel supports a master device and a slave device. These four items let you assign which kind of PIO (Programmed Input/Output) is used by IDE devices. Choose Auto to let the system auto detect which PIO mode is best, or select a PIO mode from 0-4.

**IDE Primary/Secondary Master/Slave UDMA (Auto)**

Each IDE channel supports a master device and a slave device. This mainboard supports UltraDMA technology, which provides faster access to IDE devices.

If you install a device that supports UltraDMA, change the appropriate item on this list to Auto. You may have to install the UltraDMA driver supplied with this mainboard in order to use an UltraDMA device.

Press <Esc> to return to the Integrated Peripherals screen.

► **OnChip PCI Device**

Scroll to this item and press <Enter> to view the following screen:

CMOS Setup Utility – Copyright (C) 1984 – 2001 Award Software  
OnChip PCI Device

OnChip AC97 Audio	[Auto]	Item Help
VIA-3068 MC97 Modem	[Enabled]	
VIA-3043 OnChip LAN	[Enabled]	Menu Level ►►
Onboard LAN Boot ROM	[Disabled]	

↑↓→← : Move    Enter : Select    +/-/PU/PD:Value:    F10: Save    ESC: Exit    F1:General Help  
F5:Previous Values    F6:Fail-Safe Defaults    F7:Optimized Defaults

**OnChip AC97 Audio (Auto)**

Enables and disables the onboard audio chip. Disable this item if you are going to install a PCI audio add-in card.

**VIA-3068 MC97 Modem (Enabled)**

Enables and disables the onboard modem. Disable this item if you are going to install an external modem.

**VIA-3043 OnChip LAN (Enabled)**

Enables and disables the onboard LAN.

**Onboard LAN Boot ROM (Disabled)**

Use this item to enable and disable the booting from the onboard LAN or a network add-in card with a remote boot ROM installed.

Press <Esc> to return to the Integrated Peripherals screen.

► **SuperIODevice**

Scroll to this item and press <Enter> to view the following screen:

CMOS Setup Utility – Copyright (C) 1984 – 2001 Award Software  
SuperIO Device

Onboard FDC Controller	[Enabled]	Item Help
Onboard Serial Port 1	[3F8/IRQ4]	
Onboard Serial Port 2	[2F8/IRQ3]	Menu Level ►►
UART Mode Select	[Normal]	
UR2 Duplex Mode	[Half]	
Onboard Parallel Port	[378/IRQ7]	
Parallel Port Mode	[ECP]	
ECP Mode Use DMA	[3]	
Game Port Address	[201]	
Midi Port Address	[330]	
Midi Port IRQ	[10]	

↑↓→← : Move Enter : Select +/-/PU/PD:Value: F10: Save ESC: Exit F1:General Help  
F5:Previous Values F6:Fail-Safe Defaults F7:Optimized Defaults

**Onboard FDC Controller (Enabled)**

This option enables the onboard floppy disk drive controller.

**Onboard Serial Port 1 (3F8/IRQ4)**

This option is used to assign the I/O address and interrupt request (IRQ) for the onboard serial port 1 (COM1).

**Onboard Serial Port 2 (2F8/IRQ3)**

This option is used to assign the I/O address and interrupt request (IRQ) for the onboard serial port 2 (COM2).

**UART Mode Select (Normal)**

This field is available if the Onboard Serial Port 2 field is set to any option but Disabled. UART Mode Select enables you to select the infrared communication protocol: Normal (default), IrDA, or ASKIR. IrDA is an infrared communication protocol with a maximum baud rate up to 115.2K bps. ASKIR is Sharp's infrared communication protocol with a maximum baud rate up to 57.6K bps.

**UR2 Duplex Mode (Half)**

This field is available when UART 2 Mode is set to either ASKIR or IrDA. This item enables you to determine the infrared function of the onboard infrared

chip. The options are Full and Half (default).

Full-duplex means that you can transmit and send information simultaneously. Half-duplex is the transmission of data in both directions, but only one direction at a time.

**Onboard Parallel Port (378/IRQ7)**

This option is used to assign the I/O address and interrupt request (IRQ) for the onboard parallel port.

**Parallel Port Mode (ECP)**

Enables you to set the data transfer protocol for your parallel port. There are four options: SPP (Standard Parallel Port), EPP (Enhanced Parallel Port), ECP (Extended Capabilities Port) and ECP+EPP.

SPP allows data output only. Extended Capabilities Port (ECP) and Enhanced Parallel Port (EPP) are bi-directional modes, allowing both data input and output. ECP and EPP modes are only supported with EPP- and ECP-aware peripherals.

**ECP Mode Use DMA (3)**

When the onboard parallel port is set to ECP mode, the parallel port can use DMA 3 or DMA 1.

Press <Esc> to return to the Integrated Peripherals screen.

**Init Display First (PCI Slot)**

Use this item to specify whether your graphics adapter is installed in one of the PCI slots or is integrated on the mainboard.

**OnChipUSB Controller(All Enabled)**

Enable this item if you plan to use the Universal Serial Bus ports on this mainboard.

**USB KeyboardSupport(Disabled)**

Enable this item if you plan to use a keyboard connected through the USB port in a legacy operating system (such as DOS) that does not support Plug and Play.

**IDE HDD Block Mode(Enabled)**

Enable this field if your IDE hard drive supports block mode. Block mode enables BIOS to automatically detect the optimal number of block read and writes per sector that the drive can support and improves the speed of access to IDE devices.

## Power Management Setup

The Power Management Setup Menu option is used to change the values of the chipset registers for system power management.

### Power Management Timeouts

The power-saving modes can be controlled by timeouts. If the system is inactive for a time, the timeouts begin counting. If the inactivity continues so that the timeout period elapses, the system enters a power-saving mode. If any item in the list of Reload Global Timer Events is Enabled, then any activity on that item will reset the timeout counters to zero.

### Wake Up Calls

If the system is suspended, or has been powered down by software, it can be resumed by a wake up call that is generated by incoming traffic to a modem, a LAN card, a PCI card, or a fixed alarm on the system realtime clock.

Phoenix – AwardBIOS CMOS Setup Utility  
Power Management Setup

		Item Help
ACPI function	[Enabled]	
Power Management Option	[User Define]	
HDD Power Down	[Disable]	Menu Level ▶
Suspend Mode	[Disable]	
Video Off Option	[Suspend --> Off]	
Video Off Method	[DPMS Support]	
MODEM Use IRQ	[3]	
Soft-Off by PWRBTN	[Instant-Off]	
▶ IRQ/Event Activity Detect	[Press Enter]	

↑ ↓ → ← : Move    Enter : Select    +/-/PU/PD:Value:    F10: Save    ESC: Exit    F1:General  
Help    F5:Previous Values    F6:Fail-Safe Defaults    F7:Optimized Defaults

#### ACPIFunction(Enabled)

This mainboard supports ACPI (Advanced Configuration and Power management Interface). Use this item to enable or disable the ACPI feature.

**Note:** ACPI is a power management specification that makes hardware status information available to the operating system. ACPI enables a PC to turn its peripherals on and off for improved power management. It also allows the PC to be turned on and off by external devices, so that mouse or keyboard activity wakes up the computer.

#### Power ManagementOption(User Define)

This item acts like a master switch for the power-saving modes and hard disk timeouts. If this item is set to Max Saving, power-saving modes occur after a short timeout. If this item is set to Min Saving, power-saving modes occur after

a longer timeout. If the item is set to User Define, you can insert your own timeouts for the power-saving modes.

**HDD Power Down (Disable)**

The IDE hard drive will spin down if it is not accessed within a specified length of time. Options are from 1 Min to 15 Min and Disable.

**Suspend Mode (Disable)**

The CPU clock will be stopped and the video signal will be suspended if no Power Management events occur for a specified length of time. Full power function will return when a Power Management event is detected. Options are from 1 Min to 1 Hour and Disable.

**Video Off Option (Suspend--> Off)**

This option defines if the video is powered down when the system is put into suspend mode.

**Video Off Method (DPMS Support)**

This item defines how the video is powered down to save power. This item is set to DPMS (Display Power Management Software) by default.

**MODEM Use IRQ (3)**

If you want an incoming call on a modem to automatically resume the system from a power-saving mode, use this item to specify the interrupt request line (IRQ) that is used by the modem. You might have to connect the fax/modem to the mainboard Wake On Modem connector for this feature to work.

**Soft-Off by PWRBTN (Instant-Off)**

Under ACPI (Advanced Configuration and Power management Interface) you can create a software power down. In a software power down, the system can be resumed by Wake Up Alarms. This item lets you install a software power down that is controlled by the power button on your system. If the item is set to Instant-Off, then the power button causes a software power down. If the item is set to Delay 4 Sec. then you have to hold the power button down for four seconds to cause a software power down.

► **IRQ/EventActivityDetect**

Scroll to this item and press <Enter> to view the following screen:

Phoenix – AwardBIOS CMOS Setup Utility  
IRQ/Event Activity Detect

		Item Help
VGA	[OFF]	
LPT & COM	[LPT/COM]	
HDD & FDD	[ON]	Menu Level ►►
PCI Master	[OFF]	
PowerOn by PCI Card	[Enabled]	
Wake Up On LAN/Ring	[Disabled]	
RTC Alarm Resume	[Disabled]	
x Date (of Month)	0	
x Resume Time (hh:mm:ss)	0 0 0	
► IRQs Activity Monitoring	[Press Enter]	

↑↓→← : Move    Enter : Select    +/-/PU/PD:Value:    F10: Save    ESC: Exit    F1:General Help  
F5:Previous Values    F6:Fail-Safe Defaults    F7:Optimized Defaults

This item opens a submenu that enables you to set events that will resume the system from a power saving mode.

**VGA (Off)**

When set to On, the system power will resume the system from a power saving mode if there is any VGA activity.

**LPT & COM (LPT/COM)**

When this item is enabled, the system will restart the power-saving timeout counters when any activity is detected on the serial ports, or the parallel port.

**HDD & FDD (ON)**

When this item is enabled, the system will restart the power-saving timeout counters when any activity is detected on the hard disk drive or the floppy diskette drive.

**PCI Master (OFF)**

When set to Off, any PCI device set as the Master will not power on the system.

**PowerOn by PCI Card (Enabled)**

Use this item to enable PCI activity to wakeup the system from a power saving mode.

**Wake Up On LAN/Ring (Disabled)**

Use this item to enable LAN or modem activity to wakeup the system from a power saving mode.

**RTC Alarm Resume (Disabled)**

When set to Enabled, additional fields become available and you can set the date (day of the month), hour, minute and second to turn on your system. When set to 0 (zero) for the day of the month, the alarm will power on your

system every day at the specified time.

### ▶▶ IRQs Activity Monitoring

Scroll to this item and press <Enter> to view the following screen:

Phoenix – AwardBIOS CMOS Setup Utility  
IRQs Activity Monitoring

		Item Help
Primary INTR	[ON]	
IRQ 3 (COM2)	[Enabled]	
IRQ 4 (COM1)	[Enabled]	
IRQ 5 (LPT2)	[Enabled]	
IRQ 6 (Floppy Disk)	[Enabled]	
IRQ 7 (LPT1)	[Enabled]	
IRQ 8 (RTC Alarm)	[Disabled]	
IRQ 9 (IRQ2 Redir)	[Disabled]	
IRQ 10 (Reserved)	[Disabled]	
IRQ 11 (Reserved)	[Disabled]	
IRQ 12 (PS/2 Mouse)	[Enabled]	
IRQ 13 (Coprocessor)	[Enabled]	
IRQ 14 (Hard Disk)	[Enabled]	
IRQ 15 (Reserved)	[Disabled]	

↑↓→ ← : Move Enter : Select +/-/PU/PD:Value: F10: Save ESC: Exit F1:General Help  
F5:Previous Values F6:Fail-Safe Defaults F7:Optimized Defaults

This screen enables you to set IRQs that will resume the system from a power saving mode.

Set any IRQ to Enabled to allow activity at the IRQ to wake up the system from a power saving mode.

Press <Esc> to return to the Power Management Setup screen.

## PNP/PCI Configurations

This section describes configuring the PCI bus system. PCI (Peripheral Component Interconnect) is a system, which allows I/O devices to operate at speeds nearing CPU's when they communicate with own special components.

All the options describes in this section are important and technical and it is strongly recommended that only experienced users should make any changes to the default settings.

### Phoenix - AwardBIOS CMOS Setup Utility PnP/PCI Configurations

PNP OS Installed	[No]	Item Help
Reset Configuration Data	[Disabled]	
Resources Controlled by	[Auto(ESCD)]	Menu Level ► Default is Disabled. Select Enabled to reset Extended System Con- figuration Data (ESCD) when you exit Setup if you have installed a new add- on and the system recon- figuration has caused such a serious conflict that the OS cannot boot
x IRQ Resources	Press Enter	
PCI/VGA Palette Snoop	[Disabled]	
Assign IRQ For VGA	[Enabled]	
Assign IRQ For USB	[Enabled]	
INT Pin 1 Assignment	[Auto]	
INT Pin 2 Assignment	[Auto]	
INT Pin 3 Assignment	[Auto]	

↑↓→← : Move    Enter : Select    +/-/PU/PD:Value:    F10: Save    ESC: Exit    F1:General Help  
F5:Previous Values    F6:Fail-Safe Defaults    F7:Optimized Defaults

### PNPOS Installed(No)

Setting this option to Yes allows the PnP OS (instead of BIOS) to assign the system resources such as IRQ and I/O address to the ISA PnP device. The default setting is No.

### Reset ConfigurationData (Disabled)

If you enable this item and restart the system, any Plug and Play configuration data stored in the BIOS setup is cleared from memory. New updated data is created.

### ResourcesControlledBy (Auto(ESCD))

You should leave this item at the default Auto(ESCD). Under this setting, the system dynamically allocates resources to plug and play devices as they are required.

If you cannot get a legacy ISA (Industry Standard Architecture) expansion card to work properly, you might be able to solve the problem by changing this item to Manual, and then opening up the IRQ Resources and Memory Resources sub-menus.

In the IRQ Resources sub-menu, if you change any of the IRQ assignments to Legacy ISA, then that Interrupt Request Line is reserved for a legacy ISA expansion card. Press <Esc> to close the IRQ Resources sub-menu.

In the Memory Resources sub menu, use the first item Reserved Memory Base to set the start address of the memory you want to reserve for the ISA

expansion card. Use the second item Reserved Memory Length to set the amount of reserved memory. Press <Esc> to close the Memory Resources sub-menu.

**PCI/VGAPaletteSnoop(Disabled)**

This item is designed to overcome some problems that can be caused by some non-standard VGA cards. This board includes a built-in VGA system that does not require palette snooping so you must leave this item disabled.

**AssignIRQ for VGA/USB(Enabled)**

Names the interrupt request (IRQ) line assigned to the USB/VGA (if any) on your system. Activity of the selected IRQ always awakens the system.

**PC Health Status**

*On mainboards that support hardware monitoring, this item lets you monitor the parameters for critical voltages, critical temperatures, and fan speeds.*

Phoenix – AwardBIOS CMOS Setup Utility  
PC Health Status

Target Temperature	[Disabled]	Item Help
Shutdown Temperature	[Disabled]	Menu Level ▶
Vcore		
+ 2.5V		
+ 3.3V		
+ 5V		
+ 12V		
3.3V Battery		
System Temperature		
CPU Temperature		
CPU FAN speed		
System Fan Speed		

↑↓ → ← : Move    Enter : Select    +/-/PU/PD:Value:    F10: Save    ESC: Exit    F1:General Help  
F5:Previous Values    F6:Fail-Safe Defaults    F7:Optimized Defaults

**Target Temperature(Disabled)**

This item is for CPU Throttling switch. When the CPU reached it's target temperature, the CPU Throttling will be activated. Enabling this item will protect your CPU not to overheat, but it will reduce the CPU performance.

**ShutdownTemperature(Disabled)**

Enables you to set the maximum temperature the system can reach before powering down.

**SystemComponentCharacteristics**

These fields provide you with information about the systems current operating status. You cannot make changes to these fields.

## Frequency Control

*This item enables you to set the clock speed and system bus for your system. The clock speed and system bus are determined by the kind of processor you have installed in your system.*

Phoenix – AwardBIOS CMOS Setup Utility  
Frequency Control

CPU Voltage Regulator	[Normal]	Item Help
Auto Detect DIMM/PCI Clk	[Enabled]	
Spread Spectrum Modulated	[Enabled]	Menu Level ▶
CPU Host/PCI Clock	[Default]	

↑↓→← : Move    Enter : Select    +/-/PU/PD:Value:    F10: Save    ESC: Exit    F1:General Help  
F5:Previous Values    F6:Fail-Safe Defaults    F7:Optimized Defaults

### **CPU VoltageRegulator(Normal)**

This item is used to supply the correct voltage to the CPU.

### **Auto Detect DIMM/PCIClk (Enabled)**

When this item is enabled, BIOS will disable the clock signal of free DIMM and PCI slots.

### **SpreadSpectrum(Enabled)**

If you enable spread spectrum, it can significantly reduce the EMI (Electro-Magnetic Interference) generated by the system.

### **CPU Host Clock (CPU/PCI)(Default)**

This item is used for overclocking only.

## Load Fail-Safe Defaults Option

This option opens a dialog box that lets you install fail-safe defaults for all appropriate items in the Setup Utility:

Press <Y> and then <Enter> to install the defaults. Press <N> and then <Enter> to not install the defaults. The fail-safe defaults place no great demands on the system and are generally stable. If your system is not functioning correctly, try installing the fail-safe defaults as a first step in getting your system working properly again. If you only want to install fail-safe defaults for a specific option, select and display that option, and then press <F6>.

## Load Optimized Defaults Option

This option opens a dialog box that lets you install optimized defaults for all appropriate items in the Setup Utility. Press <Y> and then <Enter> to install the defaults. Press <N> and then <Enter> to not install the defaults. The optimized defaults place demands on the system that may be greater than the performance level of the components, such as the CPU and the memory. You can cause fatal errors or instability if you install the optimized defaults when your hardware does not support them. If you only want to install setup defaults for a specific option, select and display that option, and then press <F7>.

## Set Password Option

This item can be used to install a password. To install a password, follow these steps:

1. Highlight the item Set Password on the main menu and press <Enter>.
2. The password dialog box appears.

Enter Password:

3. If you are installing a new password, type in the password. You cannot use more than eight characters or numbers. The Set Password item differentiates between upper and lower case characters. Press <Enter> after you have typed in the password. If you are deleting a password that is already installed press <Enter> when the password dialog box appears. You see a message that indicates that the password has been disabled.

PASSWORD DISABLED !!!  
Press any key to continue . . .

4. Press any key. You are prompted to confirm the password:

Confirm Password:

5. Type the password again and press <Enter>, or press <Enter> if you are deleting a password that is already installed.
6. If you typed the password correctly, the password will be installed.

## Save & Exit Setup Option

Highlight this item and press <Enter> to save the changes that you have made in the Setup Utility and exit the Setup Utility. When the Save and Exit dialog box appears, press <Y> to save and exit, or press <N> to return to the main menu:

## Exit Without Saving

Highlight this item and press <Enter> to discard any changes that you have made in the Setup Utility and exit the Setup Utility. When the Exit Without Saving dialog box appears, press <Y> to discard changes and exit, or press <N> to return to the main menu.

---

**Note:** If you have made settings that you do not want to save, use the "Exit Without Saving" item and press <Y> to discard any changes you have made.

---

This concludes Chapter 3. Refer to the next chapter for information on the software supplied with the mainboard.

## Chapter 4

# Using the Mainboard Software

---

### About the Software CD-ROM

The support software CD-ROM that is included in the mainboard package contains all the drivers and utility programs needed to properly run the bundled products. Below you can find a brief description of each software program, and the location for your mainboard version. More information on some programs is available in a README file, located in the same directory as the software.

---

**Note:** Never try to install software from a folder that is not specified for use with your mainboard.

---

Before installing any software, always inspect the folder for files named README.TXT, INSTALL.TXT, or something similar. These files may contain important information that is not included in this manual.

---

### Auto-installing under Windows 98/ME/2000/XP

The Auto-install CD-ROM makes it easy for you to install the drivers and software for your mainboard.

---

**Note:** If the Auto-install CD-ROM does not work on your system, you can still install drivers through the file manager for your OS (for example, Windows Explorer). Refer to Utility Folder Installation Notes later in this chapter.

---

The support software CD-ROM disc loads automatically under Windows 98/ME/2000/XP. When you insert the CD-ROM disc in the CD-ROM drive, the autorun feature will automatically bring up the install screen. The screen has three buttons on it, Setup, Browse CD and Exit.



---

**Note:** If the opening screen doesn't appear, double-click the file "setup.exe" in the root directory.

---

## Setup Tab

<b>Setup</b>	Click the <b>Setup</b> button to run the software installation program. Select from the menu which software you want to install.
<b>Browse CD</b>	<p>The <b>Browse CD</b> button is the standard Windows command that allows you to open Windows Explorer and show the contents of the support CD.</p> <p>Before installing the software from Windows Explorer, look for a file named README.TXT, INSTALL.TXT or something similar. This file may contain important information to help you install the software correctly.</p> <p>Some software is installed in separate folders for different operating systems, such as DOS, WIN NT, or WIN98/95. Always go to the correct folder for the kind of OS you are using.</p> <p>To install the software, execute a file named SETUP.EXE or INSTALL.EXE by double-clicking the file and then following the instructions on the screen.</p>
<b>Exit</b>	The <b>Exit</b> button closes the Auto Setup window.

## Application Tab

Lists the software utilities that are available on the CD.

## Read Me Tab

Displays the path for all software and drivers available on the CD.

## Running Setup

Follow these instructions to install device drivers and software for the mainboard:

1. Click **Setup**. The installation program begins:

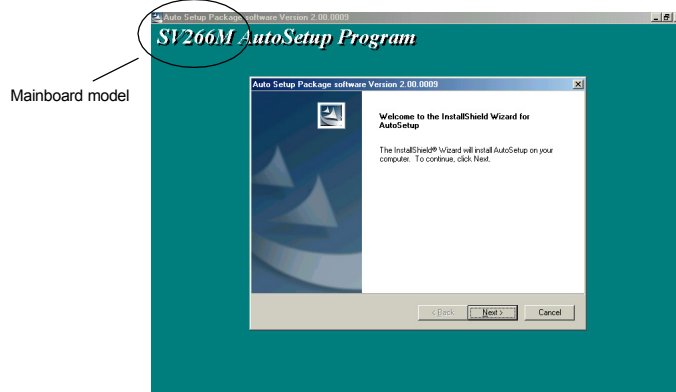

**Note:** The following screens are examples only. The screens and driver lists will be different according to the mainboard you are installing.

The mainboard identification is located in the upper left-hand corner.

2. Click **Next**. The following screen appears:

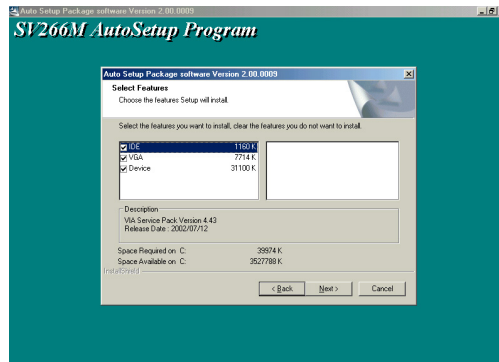

3. Check the box next to the items you want to install. The default options are recommended.
4. Click **Next** run the Installation Wizard. An item installation screen appears:

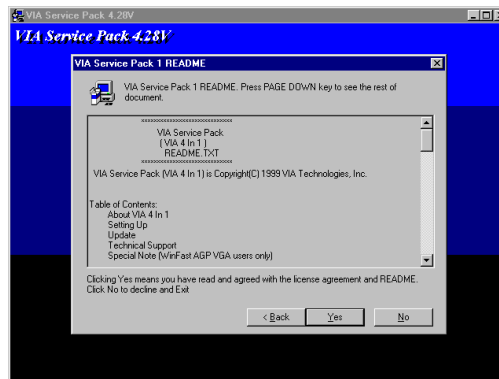

5. Follow the instructions on the screen to install the items. Drivers and software are automatically installed in sequence. Follow the on-screen instructions, confirm commands and allow the computer to restart a few times to complete the installation.

---

## Manual Installation

Insert the CD in the CD-ROM drive and locate the PATH.DOC file in the root directory. This file contains the information needed to locate the drivers for your mainboard.

Look for the chipset and mainboard model; then browse to the directory and path to begin installing the drivers. Most drivers have a setup program (SETUP.EXE) that automatically detects your operating system before installation. Other drivers have the setup program located in the operating system subfolder.

If the driver you want to install does not have a setup program, browse to the operating system subfolder and locate the readme text file (README.TXT or README.DOC) for information on installing the driver or software for your operating system.

---

## Utility Software Reference

All the utility software available from this page is Windows compliant. They are provided only for the convenience of the customer. The following software is furnished under license and may only be used or copied in accordance with the terms of the license.

---

**Note:** These software(s) are subject to change at anytime without prior notice. Please refer to the support CD for available software.

---

### AWARD Flash Memory Utility

This utility lets you erase the system BIOS stored on a Flash Memory chip on the mainboard, and lets you copy an updated version of the BIOS to the chip. Proceed with caution when using this program. If you erase the current BIOS and fail to write a new BIOS, or write a new BIOS that is incorrect, your system will malfunction. Refer to Chapter 3, *Using BIOS* for more information.

### WinFlash Utility

The Award WinFlash utility is a Windows version of the DOS Award BIOS flash writer utility. The utility enables you to flash the system BIOS stored on a Flash Memory chip on the mainboard while in a Windows environment. This utility is currently available for WINXP\ME\2000\98SE. To install the WinFlash utility, run WINFLASH.EXE from the following directory:

\UTILITY\WINFLASH 1.51

### PC-CILLIN 2002

The PC-CILLIN 2002 software program provides anti-virus protection for your system. This program is available for Windows 2000/ME/98SE/XP and Windows NT. Be sure to check the readme.txt and install the appropriate anti-virus software for your operating system.

We strongly recommend users to install this free anti-virus software to help protect your system against viruses.

### **MediaRing Talk – Telephony Software**

To install the MediaRing Talk voice modem software for the built-in modem, go to the directory \UTILITYMEDIARING TALK, then run MRTALK-SETUP72.EXE to install the application software.

### **Super Voice – Fax/Modem Software**

To install the Super Voice voice, fax, data communication application for use with the built-in fax/modem, go the directory \UTILITYSUPER\_VOICE, then run PICSHELL.EXE to install the application software.

### **PageABC**

The PageABC application software enables you to create your very own home page. To install the PageABC, go to the directory \UTILITYPageABC, and then run SETUP.EXE to install the application software.

This concludes Chapter 4.